

Heat Sink

THN-HS4

Order Code	THN-HS4 (on demand) (backorder with MOQ, non stocking item)
Compatible with	THN 10WIR, THN 10UIR, THN 15N, THN 15WIR, THN 15UIR, THN 20WIR, THN 20UIR, THN 30WIR
Thermal Impedance	Please refer to converter datasheets
Package Content	Heatsink, thermal pad and 2 clamps
Material	AL 6063
Surface Finish	Anodized (black)
Weight	7.83 g (without converter)
RoHS Exemptions	No Exemptions
Overview Link	www.tracopower.com/overview/thn-hs4

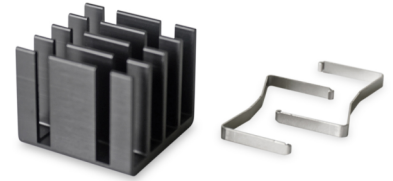

Outline Dimensions

Heat Sink

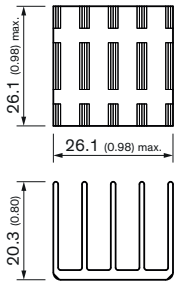

All dimensions in mm (inch)
Tolerance: x.x ±0.5 (x.xx ±0.02)
x.xx ±0.25 (x.xxx ±0.010)

Mounting Clamp

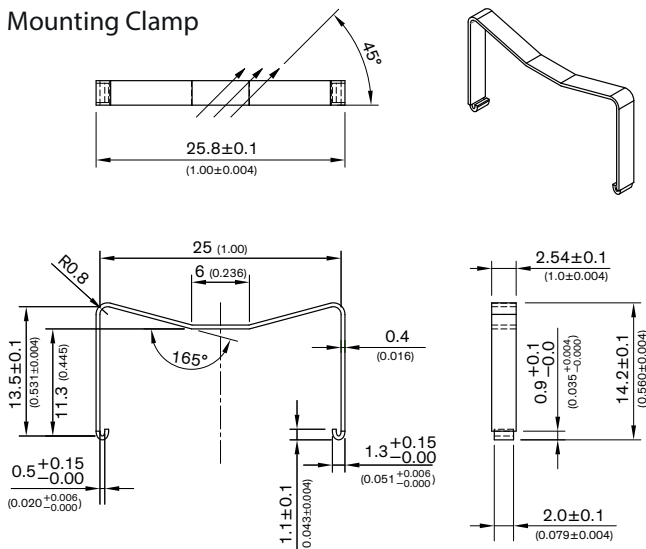

All dimensions in mm (inch)