

Heat Sink

TEP-HS6

Order Code	TEP-HS6
Compatible with	TEP 150UIR, TEP 200UIR
Thermal Impedance	Please refer to converter datasheets
Package Content	Heatsink, thermal pad and mounting screws
Material	AL 6063
Surface Finish	Anodized (black)
Weight	57.5 g (without converter)
RoHS Exemptions	No Exemptions
Overview Link	www.tracopower.com/overview/tep-hs6



Outline Dimensions

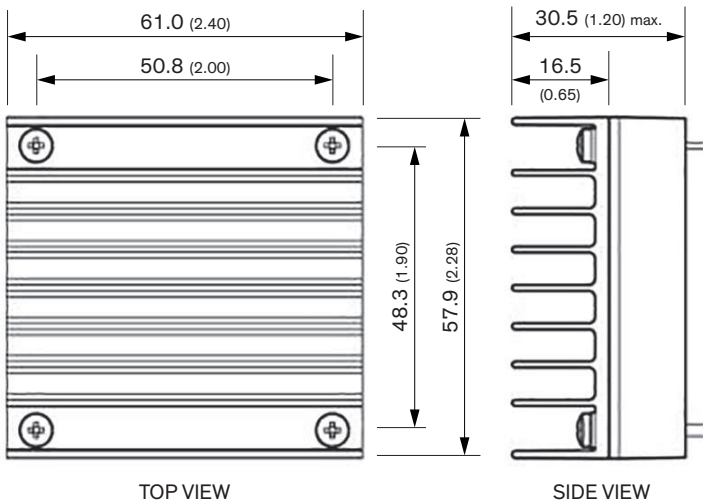

Dimensions in mm (inch)
 Tolerances: x.x ±0.5 (x.xx ±0.02)
 x.xx ±0.25 (x.xxx ±0.01)