

## Heat Sink

## TEN-HS9

<b>Order Code</b>	<b>TEN-HS9 (on demand)</b> (backorder with MOQ, non stocking item)
<b>Compatible with</b>	TEN 30UIR, TEN 40E, TEN 40WIE, TEN 40WIR, TEN 40UIR, TEN 60N, TEN 60WIN, TEN 60WIR
<b>Thermal Impedance</b>	Please refer to converter datasheets
<b>Package Content</b>	Heatsink, thermal pad and 2 clamps
<b>Material</b>	AL 6063
<b>Surface Finish</b>	Anodized (black)
<b>Weight</b>	12.7 g (without converter)
<b>RoHS Exemptions</b>	No Exemptions
<b>Overview Link</b>	<a href="http://www.tracopower.com/overview/ten-hs9">www.tracopower.com/overview/ten-hs9</a>

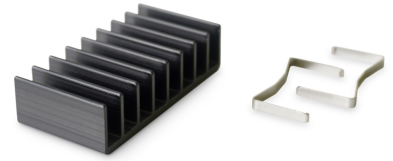

### Outline Dimensions

#### Heat Sink

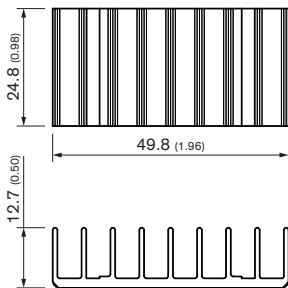

All dimensions in mm (inch)  
Tolerance: x.x ±0.5 (x.xx ±0.02)  
x.xx ±0.25 (x.xxx ±0.010)

#### Mounting Clamp

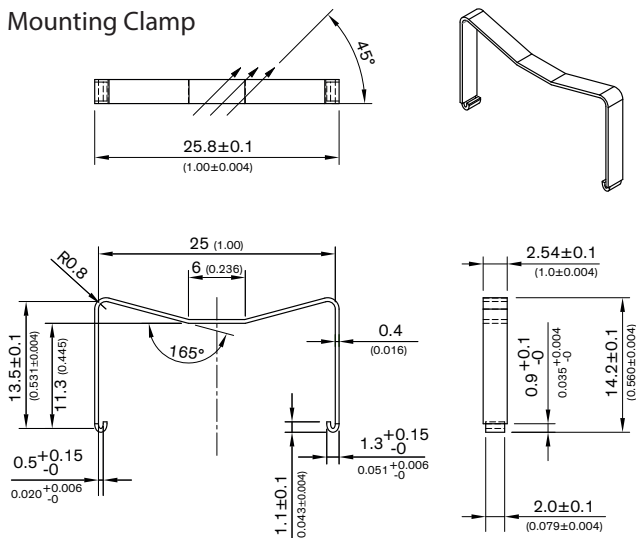

All dimensions in mm (inch)