

Order Code	TCK-131
Inductance	15 μ H \pm 20% (at 1 kHz / 1 V)
Impedance (DCR)	235 m Ω max.
Rated Current	0.85 A max.
Operating Temperature	-40°C to +125°C
RoHS Exemptions	No Exemptions
Overview Link	www.tracopower.com/overview/tck-131

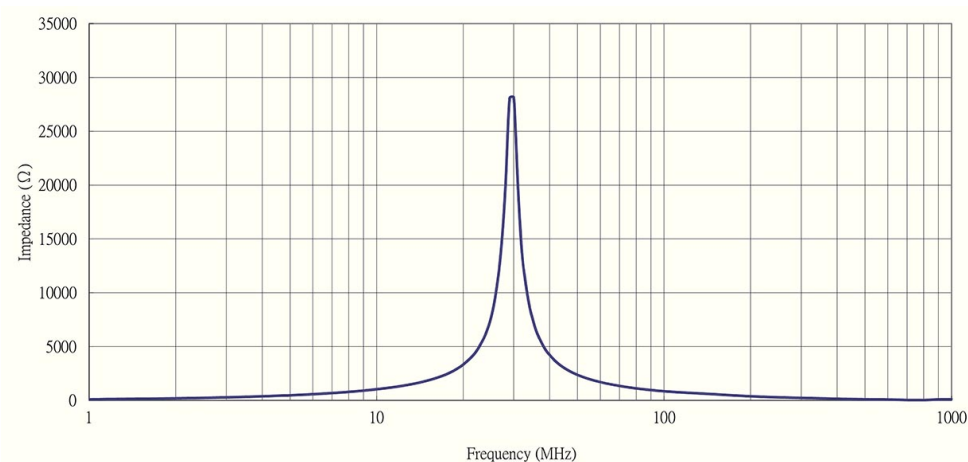

Impedance Curve



Outline Dimensions

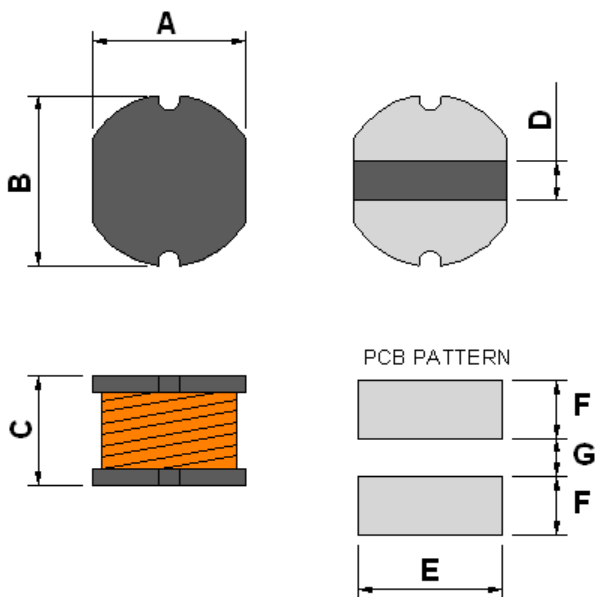

Dimensions [mm]	
A	4.0 \pm 0.5
B	4.5 \pm 0.5
C	3.2 \pm 0.5
D	1.2 typ.
E	4.5
F	1.75
G	1.5

All specifications valid at +25°C, unless otherwise stated.