

Order Code	TCK-127
Inductance (each winding)	137 $\mu\text{H} \pm 25\%$ (at 10 kHz / 50 mV)
Impedance (DCR)	24 m Ω max.
Rated Current	1.92 A max.
Rated Voltage	500 VDC max. (between windings)
Operating Temperature	-40°C to +105°C
RoHS Exemptions	No Exemptions
Overview Link	www.tracopower.com/overview/tck-127

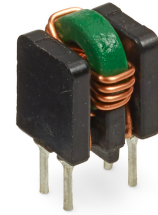

Impedance Curve

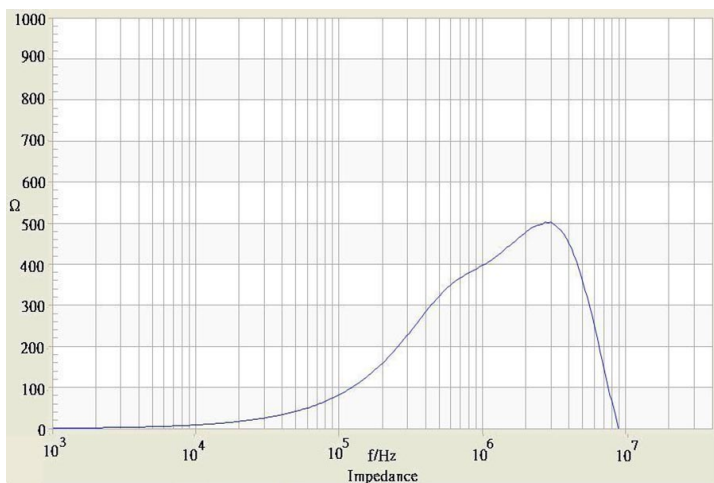

Outline Dimensions

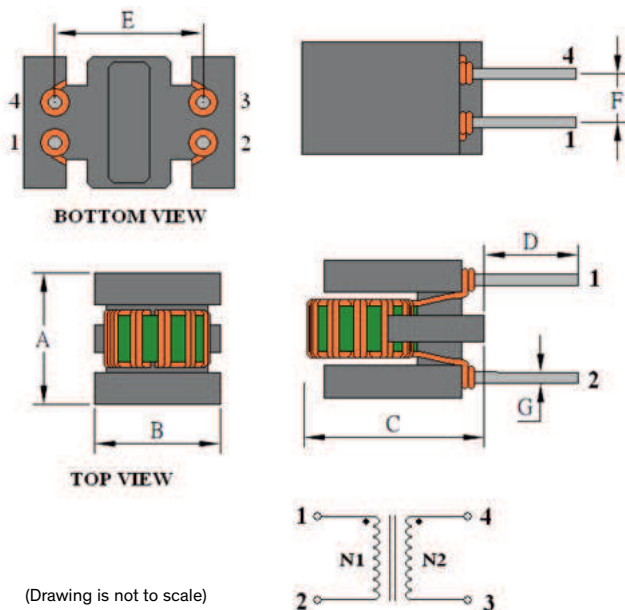

Dimensions [mm]

A	7.9 max.
B	8.5 max.
C	10.5 max.
D	3.5 \pm 1.0
E	5.08 \pm 0.5
F	2.54 \pm 0.3
G	0.6 \pm 0.1

All specifications valid at +25°C, unless otherwise stated.