

TEST REPORT

CERTIFICATE OF CONFORMITY

Standard: EN 55032: 2015+A11:2020, Class A
EN 61000-3-2: 2014 (Not Applicable)
EN IEC 61000-3-2: 2019+A1:2021 (Not Applicable)
EN 61000-3-3: 2013+A1:2019+A2:2021 (Not Applicable)
EN 55035: 2017+A11:2020

Report No.: CEBCAE-WTW-P23030110

Product: DC to DC Converter

Brand:



Model No.: TMU 3-0511, TMU 3-1211, TMU 3-1213, TMU 3-2411, TMU 3-2413

Series Model: Refer to item 3.1

Received Date: 2023/1/16

Test Date: 2023/1/18 ~ 2023/2/1

Issued Date: 2023/3/7

Applicant: TRACO ELECTRONIC AG

Address: SIHLBRUGGSTRASS 111 CH-6340 BAAR, SWITZERLAND

Issued By: Bureau Veritas Consumer Products Services (H.K.) Ltd., Taoyuan Branch
Lin Kou Laboratories

Lab Address: No. 47-2, 14th Ling, Chia Pau Vil., Lin Kou Dist., New Taipei City, Taiwan

Test Location: No. 47-2, 14th Ling, Chia Pau Vil., Lin Kou Dist., New Taipei City, Taiwan

Approved by:

Jim Hsiang
Jim Hsiang / Associate Technical Manager

Date:

2023/3/7

This test report consists of 77 pages in total. It may be duplicated completely for legal use with the approval of the applicant. It should not be reproduced except in full, without the written approval of our laboratory. The test results in the report only apply to the tested sample. The test results in this report are traceable to the national or international standards.

Prepared by : Albee Chu / Senior Specialist



This report is governed by, and incorporates by reference, the Conditions of Testing as posted at the date of issuance of this report at <http://www.bureauveritas.com/home/about-us/our-business/cps/about-us/terms-conditions/>, and is intended for your exclusive use. Any copying or replication of this report to or for any other person or entity, or use of our name or trademark, is permitted only with our prior written permission. This report sets forth our findings solely with respect to the test samples identified herein. The results set forth in this report are not indicative or representative of the quality or characteristics of the lot from which a test sample was taken or any similar or identical product unless specifically and expressly noted. Our report includes all of the tests requested by you and the results thereof based upon the information that you provided to us. Measurement uncertainty is only provided upon request for accredited tests. Statements of conformity are based on simple acceptance criteria without taking measurement uncertainty into account, unless otherwise requested in writing. You have 60 days from date of issuance of this report to notify us of any material error or omission caused by our negligence or if you require measurement uncertainty; provided, however, that such notice shall be in writing and shall specifically address the issue you wish to raise. A failure to raise such issue within the prescribed time shall constitute your unqualified acceptance of the completeness of this report, the tests conducted and the correctness of the report contents.

Table of Contents

Release Control Record	4
1 Certificate	5
2 Summary of Test Results	6
2.1 Performance Criteria	6
2.2 Measurement Uncertainty	8
2.3 Supplementary Information	9
3 General Information	10
3.1 Description of EUT	10
3.2 Primary Clock Frequencies of Internal Source	10
3.3 Features of EUT	10
3.4 Package Specifications by Manufacturer	11
3.5 Operating Modes of EUT and Determination of Worst Case Operating Mode	13
3.6 Test Program Used and Operation Descriptions	13
3.7 Connection Diagram of EUT and Peripheral Devices	14
3.8 Configuration of Peripheral Devices and Cable Connections	15
4 Test Instruments	16
4.1 Conducted Emissions from Power Ports	16
4.2 Radiated Emissions up to 1 GHz	17
4.3 Electrostatic Discharges (ESD)	17
4.4 Radio Frequency Electromagnetic Field (RS)	18
4.5 Fast Transients Common Mode (EFT)	18
4.6 Surges	19
4.7 Radio Frequency Common Mode (CS)	19
4.8 Power Frequency Magnetic Field (PFMF)	20
5 Limits of Test Items	21
5.1 Conducted Emissions from Power Ports	21
5.2 Radiated Emissions up to 1 GHz	21
5.3 General immunity requirements	22
6 Test Arrangements	24
6.1 Conducted Emissions from Power Ports	24
6.2 Radiated Emissions up to 1 GHz	25
6.3 Electrostatic Discharges (ESD)	26
6.4 Radio Frequency Electromagnetic Field (RS)	28
6.5 Fast Transients Common Mode (EFT)	29
6.6 Surges	30
6.7 Radio Frequency Common Mode (CS)	32
6.8 Power Frequency Magnetic Field (PFMF)	34
7 Test Results of Test Item	35
7.1 Conducted Emissions from Power Ports	35
7.2 Radiated Emissions up to 1 GHz	45
7.3 Electrostatic Discharges (ESD)	55
7.4 Radio Frequency Electromagnetic Field (RS)	56
7.5 Fast Transients Common Mode (EFT)	57
7.6 Surges	58
7.7 Radio Frequency Common Mode (CS)	59
7.8 Power Frequency Magnetic Field (PFMF)	59
8 Pictures of Test Arrangements	60
8.1 Conducted Emissions from Power Ports	60
8.2 Radiated Emissions up to 1 GHz	65
8.3 Electrostatic Discharges (ESD)	70
8.4 Radio Frequency Electromagnetic Field (RS)	71
8.5 Fast Transients Common Mode (EFT)	72



8.6	Surges	74
8.7	Radio Frequency Common Mode (CS)	76
8.8	Power Frequency Magnetic Field (PFMF)	76
9	Information of the Testing Laboratories	77



Release Control Record

Issue No.	Description	Date Issued
CEBCAE-WTW-P23030110	Original release.	2023/3/7

1 Certificate

Product: DC to DC Converter



Test Model: TMU 3-0511, TMU 3-1211, TMU 3-1213, TMU 3-2411, TMU 3-2413

Series Model: Refer to item 3.1

Sample Status: Engineering Sample

Applicant: TRACO ELECTRONIC AG

Test Date: 2023/1/18 ~ 2023/2/1

Standard: EN 55032: 2015+A11:2020, Class A
EN 61000-3-2: 2014 (Not Applicable)
EN IEC 61000-3-2: 2019+A1:2021 (Not Applicable)
EN 61000-3-3: 2013+A1:2019+A2:2021 (Not Applicable)
EN 55035: 2017+A11:2020

Measurement procedure: EN 61000-4-2: 2009 / IEC 61000-4-2: 2008 ED. 2.0
EN IEC 61000-4-3: 2020 / IEC 61000-4-3: 2020 ED. 4.0
EN 61000-4-4: 2012 / IEC 61000-4-4: 2012 ED. 3.0
EN 61000-4-5: 2014+A1:2017 / IEC 61000-4-5: 2017 ED. 3.1
EN 61000-4-6: 2014+AC:2015 / IEC 61000-4-6: 2013 ED. 4.0
EN 61000-4-8: 2010 / IEC 61000-4-8: 2009 ED. 2.0
EN IEC 61000-4-11: 2020+AC:2020 / IEC 61000-4-11: 2020 ED. 3.0 (Not Applicable)

The above equipment has been tested by **Bureau Veritas Consumer Products Services (H.K.) Ltd., Taoyuan Branch**, and found compliance with the requirement of the above standards. The test record, data evaluation & Equipment Under Test (EUT) configurations represented herein are true and accurate accounts of the measurements of the sample's EMC characteristics under the conditions specified in this report.

2 Summary of Test Results

The test items that the EUT need to perform in accordance with its interfaces, evaluated functions are as follows:

Standard	Test Item	Result	Remark
EN 55032	Conducted Emissions from Power Ports	Pass	Minimum passing Class A margin is -28.91 dB at 29.89200 MHz
EN 55032	Radiated Emissions up to 1 GHz	Pass	Minimum passing Class A margin is -6.50 dB at 63.93 MHz
IEC 61000-4-2	Electrostatic Discharges (ESD)	Pass	For EN 55035 Performance Criteria A
IEC 61000-4-3	Radio Frequency Electromagnetic Field (RS)	Pass	For EN 55035 Performance Criteria A
IEC 61000-4-4	Fast Transients Common Mode (EFT)	Pass	For EN 55035 Performance Criteria A
IEC 61000-4-5	Surges	Pass	For EN 55035 Performance Criteria A
IEC 61000-4-6	Radio Frequency Common Mode (CS)	Pass	For EN 55035 Performance Criteria A
IEC 61000-4-8	Power Frequency Magnetic Field (PFMF)	Pass	For EN 55035 Performance Criteria A

Note: Determining compliance based on the results of the compliance measurement, not taking into account measurement instrumentation uncertainty.

2.1 Performance Criteria

General Performance Criteria

These criteria shall be used during the testing of primary functions where no specified in the normative annexes of EN 55035 is applicable.

Performance criterion A

The equipment shall continue to operate as intended without operator intervention. No degradation of performance, loss of function or change of operating state is allowed below a performance level specified by the manufacturer when the equipment is used as intended. The performance level may be replaced by a permissible loss of performance. If the minimum performance level or the permissible performance loss is not specified by the manufacturer, then either of these may be derived from the product description and documentation, and by what the user may reasonably expect from the equipment if used as intended.

Performance criterion B

During the application of the disturbance, degradation of performance is allowed. However, no unintended change of actual operating state or stored data is allowed to persist after the test.

After the test, the equipment shall continue to operate as intended without operator intervention; no degradation of performance or loss of function is allowed, below a performance level specified by the manufacturer, when the equipment is used as intended. The performance level may be replaced by a permissible loss of performance.

If the minimum performance level (or the permissible performance loss), or recovery time, is not specified by the manufacturer, then either of these may be derived from the product description and documentation, and by what the user may reasonably expect from the equipment if used as intended.

Performance criterion C

Loss of function is allowed, provided the function is self-recoverable, or can be restored by the operation of the controls by the user in accordance with the manufacturer's instructions. A reboot or re-start operation is allowed.

Information stored in non-volatile memory, or protected by a battery backup, shall not be lost.

Product Specific Performance criteria for network functions

Equipment that provides these functions transmits and receives data through ports such as an analogue/digital data port. The networking functions are just like network switching and routing ; data transmission ; supervisory...etc.

The particular performance criteria which are specified in the normative annexes of CISPR 35/ EN 55035 take precedence over the corresponding parts of the general performance criteria.

Performance criterion A

Where relevant, during the application of the test the network function shall, as a minimum, operate ensuring that:

- established connections shall be maintained throughout the application of the test;
- no change of operational state or corruption of stored data occurs;
- no increase in error rate above the figure defined by the manufacturer occurs. The manufacturer should select the most appropriate performance measurement criteria for the product or system, for example bit error rate, block error rate;
- no request for retry above the figure defined by the manufacturer;
- the data transmission rate does not reduce below the figure defined by the manufacturer;
- no protocol failure occurs;
- other verifications are described in F.3.3.1 of CISPR 35/ EN 55035.

Performance criterion B

Established connections shall be maintained throughout the test, or shall self-recover in a way and timescale that is imperceptible to the user.

The error rate, request for retry and data transmission rates may be degraded during the application of the test. Degradation of the performance as described in criterion A is permitted, provided that the normal operation of the EUT is self-recoverable to the condition established prior to the application of the test.

Where required, as defined in Clause 5 of CISPR 35/ EN 55035, the acceptable operation of the function shall be verified at the completion of the test as described in Table H.1 of CISPR 35/ EN 55035, by confirming the following:

- the EUT's ability to establish a connection,
- the EUT's ability to clear a connection.

During surge testing disconnection is allowed on the analogue/digital data port being tested.

If the EUT is a supervisory equipment, it shall not impact the normal operation of the network being monitored. In addition, any supervisory functions impacted during the period of the test shall return to the state prior to the test. Elements to consider include: alarms, signalling lamps, printer output, network traffic rates, network monitoring.

Performance criterion C

Degradation of performance as described in criteria A and B is permitted provided that the normal operation of the EUT is self-recoverable to the condition immediately before the application of the test, or can be restored after the test by the operator.

Product Specific Performance Criteria for xDSL

The particular performance criteria which are specified in the normative annexes of CISPR 35/ EN 55035 take precedence over the corresponding parts of the general performance criteria.

Performance criterion A

Applicable for the test requirement defined in table clause 2.1 of EN 55035

During the swept frequency test the established connection shall be maintained throughout the testing and the information transferred without any additional reproducible errors or loss of synchronisation. If a degradation in performance is observed and the system is adaptive, for example has the capability to automatically retrain in the presence of an interfering signal, then for conducted immunity tests only, the following procedure shall be followed:

- a) For each range of interfering frequencies in which degradation in performance is observed, three frequencies (beginning, middle and end) shall be identified.
- b) At each of the frequencies identified in step a), the interfering signal shall be turned on and the system is allowed to retrain.
- c) If the system is able to retrain and then functions correctly for a dwell time of at least 60 seconds without any additional reproducible errors or loss of synchronisation, then the performance level of the system is considered acceptable.
- d) The frequencies identified in step a) and the data rates achieved in step b) shall be recorded in the test report.

Applicable for the test requirement defined in table clause 2.2 of EN 55035

It is important that the modems are able to train in the presence of repetitive impulsive noise and minimize disruption to the end-user where a repetitive impulsive noise source starts after the link has synchronized. Therefore the following procedure and performance criteria shall apply.

The manufacturer shall select the class of impulsive noise protection (INP) to be used for the immunity test and should state this information in the technical documentation and in the test report. The maximum delay shall be set to 8 ms.

In the absence of impulsive noise: The modem shall operate without retraining at its target noise margin with a bit rate value depending on the line attenuation and the stationary noise being present on the line. (The actual value will be between the minimum and maximum bit rate values programmed in the port).

The impulsive noise source shall then be applied at the required test level.

With the impulsive noise applied: The modem shall operate without retraining and without SES at the bit rate established prior to the application of the impulsive noise. No extra CRC errors shall occur due to the impulsive noise.

After the test, the noise margin value shall return to the target noise margin.

Performance criterion B

Applicable for the test requirement defined in table clause 2.3 of EN 55035

Modems shall withstand the occurrence of isolated impulsive noise events. The performance criteria defined in below Table shall be applied.

Impulse duration (ms)	Performance criteria
0.24	The application of the impulse shall not cause the xDSL link to lose synchronisation. No CRC errors are permitted.
10	The application of the 5 impulses shall result in less than 75 CRC errors and shall not cause the link to lose synchronisation.
300	The application of the impulse shall not cause the xDSL link to lose synchronisation.

Applicable for the test requirements defined in table clauses 2.5 and 4.5 of EN 55035

For application of this test to the xDSL port, a repetition rate of 100 kHz (burst length 0.75 ms) shall be used.

Degradation of the performance as described in criterion A is permitted in that errors are acceptable during the application of the test. However the application of the test shall not cause the system to lose the established connection or re-train. At the cessation of the test the system shall operate in the condition established prior to the application of the test without user intervention.

After the application of the EFT/B tests to the xDSL or AC mains port, the CRC error count shall not have increased by more than 600 when compared to the count prior to the application of the test.

Performance criterion C

Degradation of the performance as described in criteria A and B is permitted provided that the normal operation of the EUT is self-recoverable to the condition established prior to application of the test or can be restored after the test by the operator.

2.2 Measurement Uncertainty

Where relevant, the following measurement uncertainty levels have been estimated for tests performed on the EUT as specified in CISPR 16-4-2:

Measurement	Specification	Expanded Uncertainty (k=2) (±)	Maximum allowable uncertainty (±)
Conducted Emissions from Power Ports	150 kHz ~ 30 MHz	3.00 dB	3.4 dB (U_{CISPR})
Radiated Emissions up to 1 GHz	30 MHz ~ 1 GHz	3m : 5.72 dB 10m : 4.38 dB	6.3 dB (U_{CISPR})

The other instruments specified are routine verified to remain within the calibrated levels, no measurement uncertainty is required to be calculated.

2.3 Supplementary Information

There is not any deviation from the test standards for the test method.

Specific Immunity Requirements by applicant.

standard	Test Item	Test Specification	Performance Criteria
IEC 61000-4-2	Electrostatic Discharges (ESD)	±6 kV (contact)	A
IEC 61000-4-3	Radio Frequency Electromagnetic Field (RS)	Swept Frequency Test: 80 to 1000(MHz), 10V/m, 80 % AM (1 kHz) Spot Frequency Test: 1800, 2600, 3500, 5000 MHz, 10V/m, 80% AM (1kHz)	A
IEC 61000-4-4	Fast Transients Common Mode (EFT)	Input DC power port: ±2kV, 5/50 (Tr/Th) ns, 5kHz	A
IEC 61000-4-5	Surges	Input DC power port: ±1kV, 1.2/50 (8/20) (Tr/Th) µs,	A
IEC 61000-4-6	Radio Frequency Common Mode (CS)	Input DC power port: 0.15-80 MHz, 10V, 80% AM (1kHz)	A
IEC 61000-4-8	Power Frequency Magnetic Field (PFMF)	Enclosure port: 50 Hz, 30A/m,	A

3 General Information

3.1 Description of EUT

Product	DC to DC Converter
Brand	
Test Model	TMU 3-0511, TMU 3-1211, TMU 3-1213, TMU 3-2411, TMU 3-2413
Series Model	Refer to Note as below
Model Difference	Marketing Differentiation
Sample Status	Engineering Sample
Operating Software	N/A
Power Supply Rating	Refer to note as below
Accessory Device	N/A
Data Cable Supplied	N/A

Note:

1. This report is issued as a duplicate report of BV CPS report no.: CEBCAE-WTW-P23010419. The difference compared with original report are changing applicant, model and brand for marketing purpose; therefore all test data was copied from the original test report.
2. The EUT is a DC to DC Converter, the specifications of standard models were listed as below.

Model Number	Input Voltage (Range)	Output Voltage
	VDC	VDC
TMU 3-0511	5	5
TMU 3-0512	(4.5 ~ 5.5)	12
TMU 3-0513		15
TMU 3-1211	12	5
TMU 3-1212	(10.8 ~ 13.2)	12
TMU 3-1213		15
TMU 3-2411	24	5
TMU 3-2412	(21.6 ~ 26.4)	12
TMU 3-2413		15

During the test, the **Model No.: TMU 3-0511, TMU 3-1211, TMU 3-1213, TMU 3-2411, TMU 3-2413** were selected as the representative models for the test and therefore only their test data were recorded in this report.

3.2 Primary Clock Frequencies of Internal Source

The highest frequency generated or used within the EUT or on which the EUT operates or tunes is below 108MHz, provided by TRACO ELECTRONIC AG, for detailed internal source, please refer to the manufacturer's specifications.

3.3 Features of EUT

The tests reported herein were performed according to the method specified by TRACO ELECTRONIC AG, for detailed feature description, please refer to the manufacturer's specifications or user's manual.

Please refer to appendix of the report if the applicant has provided additional descriptions of the EUT.

3.4 Package Specifications by Manufacturer

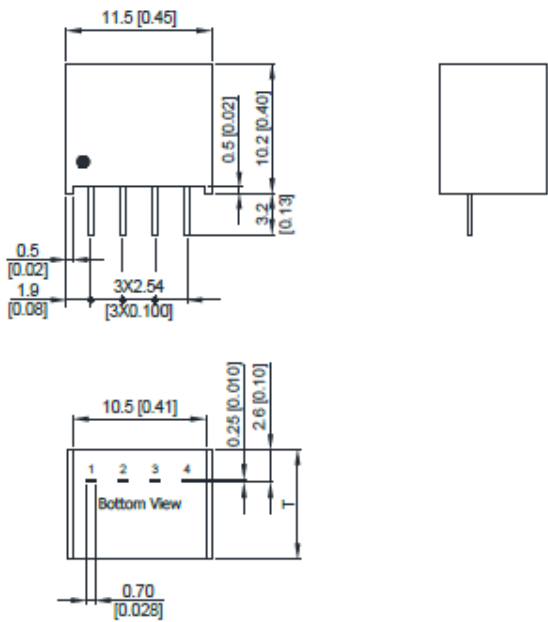
Package Specifications											
<p>Mechanical Dimensions</p>  <p>The drawing shows a top view and a bottom view of the package. The top view dimensions are: width 11.5 [0.45], height 10.2 [0.40], and a small offset of 0.5 [0.02]. The bottom view shows a width of 10.5 [0.41] and a distance of 0.70 [0.028] from the left edge to the start of the pins. Pin dimensions include a diameter of 0.5 [0.02] and a pitch of 2.54 [0.100]. The pin length is 3.2 [0.13].</p>	<p>Pin Connections</p> <table border="1"> <thead> <tr> <th>Pin</th> <th>Single Output</th> </tr> </thead> <tbody> <tr> <td>1</td> <td>-Vin</td> </tr> <tr> <td>2</td> <td>+Vin</td> </tr> <tr> <td>3</td> <td>-Vout</td> </tr> <tr> <td>4</td> <td>+Vout</td> </tr> </tbody> </table> <p>T: 8.6mm(0.34 inch) for 5V & 12V Input Models T: 9.6mm(0.38 inch) for 24V Input Models</p> <ul style="list-style-type: none"> ▶ All dimensions in mm (inches) ▶ Tolerance: X.X±0.5 (X.XX±0.02) X.XX±0.25 (X.XXX±0.01) ▶ Pins ±0.05 (±0.002) 	Pin	Single Output	1	-Vin	2	+Vin	3	-Vout	4	+Vout
Pin	Single Output										
1	-Vin										
2	+Vin										
3	-Vout										
4	+Vout										

Physical Characteristics

Case Size (5V & 12V Input)	: 11.5x10.2x8.6mm (0.45x0.40x0.34 inches)
Case Size (24V Input)	: 11.5x10.2x9.6mm (0.45x0.40x0.38 inches)
Case Material	: Plastic resin (flammability to UL 94V-0 rated)
Pin Material	: Phosphor Bronze
Weight (5V & 12V Input)	: 3.20g
Weight (24V Input)	: 3.40g

External Filter meets Total solution (for EFT & Surge & EMI) EN 55032, class A

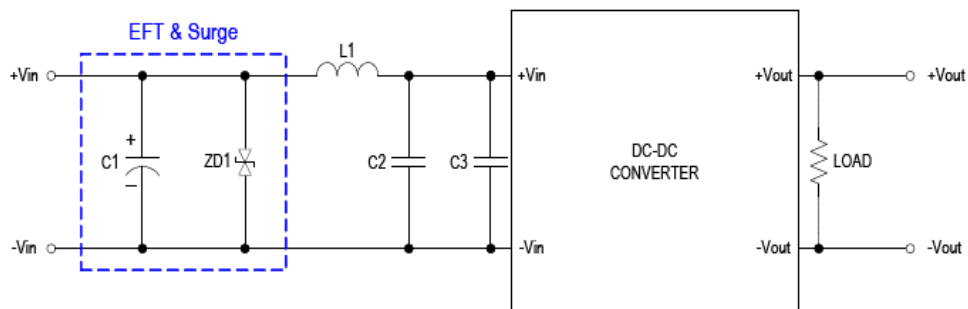

Model	C1	ZD1	L1	C2	C3
TMU 3-05XX	330 μ F/16V CHEMI-CON KY Series	1.5KE7.5CA (TVS Diode)	3.3 μ H/1.25A/2512 WE-LQ SMD Inductor 74404024033	22 μ F/35V 1206 X5R	1 μ F/100V 1206 X7R
TMU 3-12XX	470 μ F/16V CHEMI-CON KY Series	1.5KE18CA (TVS Diode)	3.3 μ H/1.25A/2512 WE-LQ SMD Inductor 74404024033	22 μ F/35V 1206 X5R	1 μ F/100V 1206 X7R
TMU 3-24XX	560 μ F/35V CHEMI-CON KZH Series	1.5KE33CA (TVS Diode)	3.3 μ H/1.25A/2512 WE-LQ SMD Inductor 74404024033	22 μ F/35V 1206 X5R	1 μ F/100V 1206 X7R

3.5 Operating Modes of EUT and Determination of Worst Case Operating Mode

The EUT has been pre-tested under following test modes.

Test Condition	
Mode	Radiated Emissions up to 1 GHz
1	TMU 3-0511 + Full Load + Input Power(5 Vdc)
2	Standby mode

Notes: The worst case is that mode 1 is shown in bold.

As client's requirement, test modes are presented in the report as below.

Test Condition	
Mode	Conducted Emissions from Power Ports
A	TMU 3-0511 + Full Load + Input Power(5 Vdc)
B	TMU 3-1211 + Full Load + Input Power(12 Vdc)
C	TMU 3-1213 + Full Load + Input Power(12 Vdc)
D	TMU 3-2411 + Full Load + Input Power(24 Vdc)
E	TMU 3-2413 + Full Load + Input Power(24 Vdc)
Mode	Radiated Emissions up to 1 GHz
A	TMU 3-0511 + Full Load + Input Power(5 Vdc)
B	TMU 3-1211 + Full Load + Input Power(12 Vdc)
C	TMU 3-1213 + Full Load + Input Power(12 Vdc)
D	TMU 3-2411 + Full Load + Input Power(24 Vdc)
E	TMU 3-2413 + Full Load + Input Power(24 Vdc)
Mode	Electrostatic Discharges (ESD)
A	TMU 3-2413 + Full Load + Input Power(24 Vdc)
Mode	Radio Frequency Electromagnetic Field (RS)
A	TMU 3-2413 + Full Load + Input Power(24 Vdc)
Mode	Fast Transients Common Mode (EFT)
A	TMU 3-0511 + Full Load + Input Power(5 Vdc)
B	TMU 3-1213 + Full Load + Input Power(12 Vdc)
C	TMU 3-2413 + Full Load + Input Power(24 Vdc)
Mode	Surges
A	TMU 3-0511 + Full Load + Input Power(5 Vdc)
B	TMU 3-1213 + Full Load + Input Power(12 Vdc)
C	TMU 3-2413 + Full Load + Input Power(24 Vdc)
Mode	Radio Frequency Common Mode (CS)
A	TMU 3-2413 + Full Load + Input Power(24 Vdc)
Mode	Power Frequency Magnetic Field (PFMF)
A	TMU 3-2413 + Full Load + Input Power(24 Vdc)

3.6 Test Program Used and Operation Descriptions

For Emission test

Set the EUT under full resistor load.

For Immunity test

Connected a resistor load to DC output port of EUT to make EUT have maximum power consumption and installed both of them into a metal case then multimeter was used to monitor voltage of output.

3.7 Connection Diagram of EUT and Peripheral Devices

For Conduction test

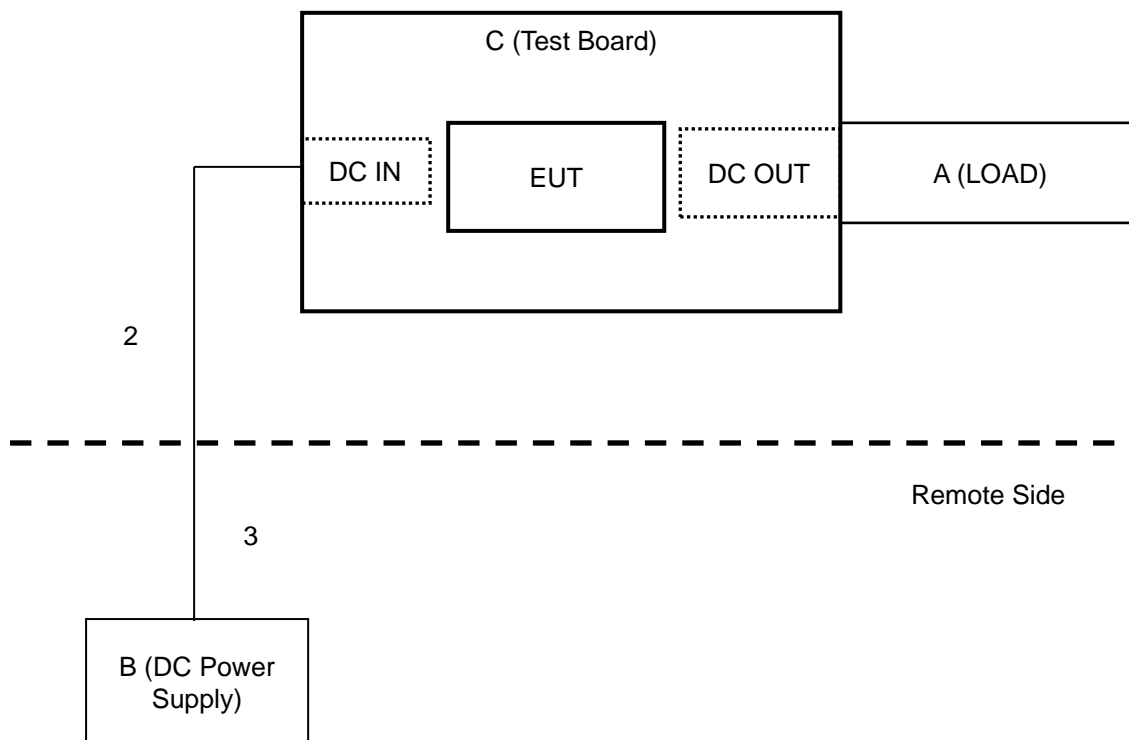

For Radiated test

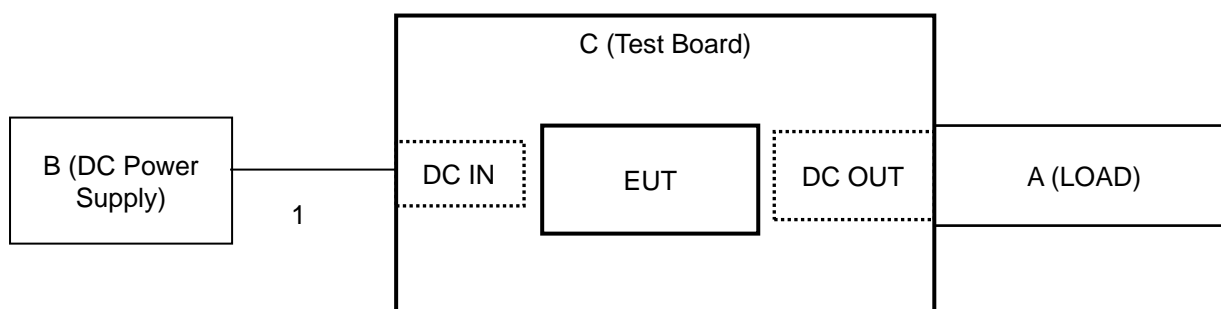

For Immunity test

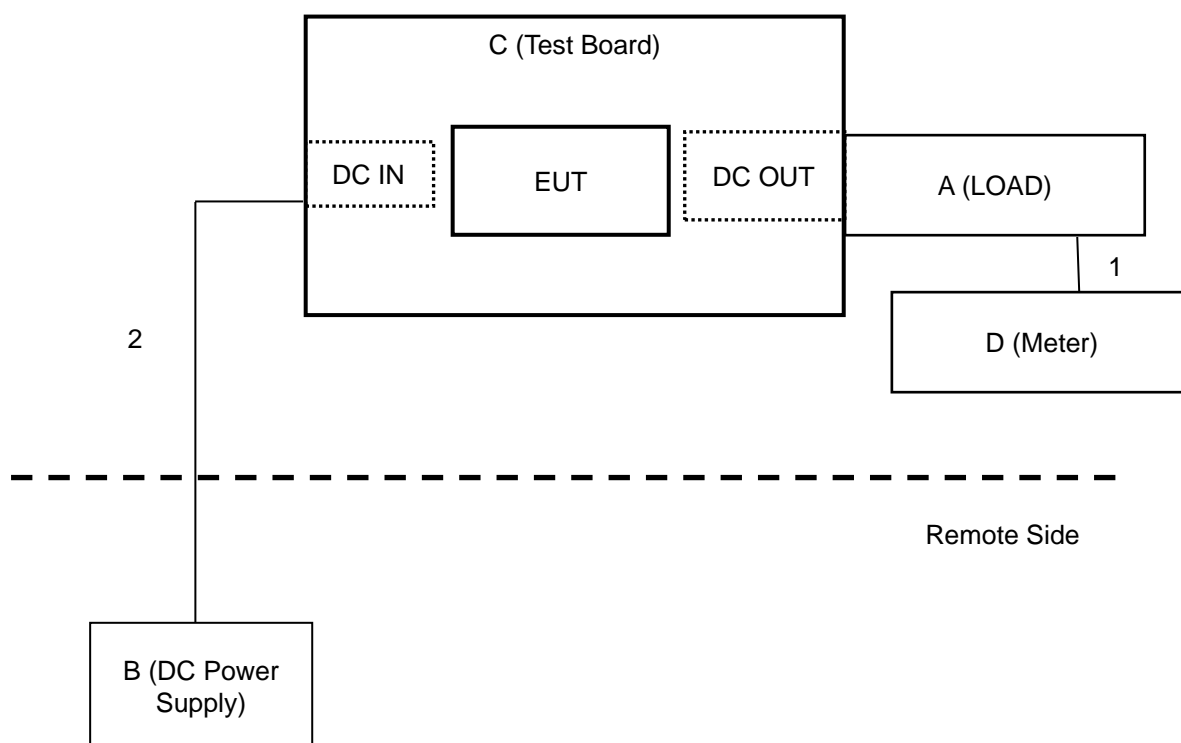

3.8 Configuration of Peripheral Devices and Cable Connections

For Emission test

ID	Product	Brand	Model No.	Serial No.	FCC ID	Remarks
A	LOAD	N/A	N/A	N/A	N/A	Supplied by applicant
B	DC Power Supply	HILA	DP6010	1616AP051502087	N/A	Provided by Lab
C	TEST BOARD	N/A	N/A	N/A	N/A	Supplied by applicant

ID	Cable Descriptions	Qty.	Length (m)	Shielding (Yes/No)	Cores (Qty.)	Remarks
1	DC power cable	1	0.5	No	0	Provided by Lab
2	DC power cable	1	1	No	0	Provided by Lab
3	DC power cable	1	1	No	0	Provided by Lab

For Immunity test

ID	Product	Brand	Model No.	Serial No.	FCC ID	Remarks
A	LOAD	N/A	N/A	N/A	N/A	Supplied by applicant
B	DC Power Supply	HILA	DP6010	1616AP051502087	N/A	Provided by Lab
C	TEST BOARD	N/A	N/A	N/A	N/A	Supplied by applicant
D	METER	YFE	YF-370A	N/A	N/A	Provided by Lab

ID	Cable Descriptions	Qty.	Length (m)	Shielding (Yes/No)	Cores (Qty.)	Remarks
1	DC power cable	1	0.5	No	0	Provided by Lab
2	DC power cable	1	2	No	0	Provided by Lab

4 Test Instruments

The calibration interval of the all test instruments are 12 months and the calibrations are traceable to NML/ROC and NIST/USA.

4.1 Conducted Emissions from Power Ports

Description Manufacturer	Model No.	Serial No.	Calibrated Date	Calibrated Until
50 ohm terminal LYNICS	0900510	E1-011285	2022/9/19	2023/9/18
		E1-011286	2022/9/19	2023/9/18
50 Ohms Terminator LYNICS	0900510	E1-01-305	2022/2/9	2023/2/8
Attenuator STI	STI02-2200-10	NO.4	2022/9/2	2023/9/1
DC LISN R&S	ESH3-Z6	100219	2022/8/2	2023/8/1
		844950/018	2022/8/2	2023/8/1
DC LISN Schwarzbeck	NNLK 8121	8121-808	2022/4/29	2023/4/28
High Voltage Probe Schwarzbeck	TK9420	00982	2022/12/14	2023/12/13
Isolation Transformer Erika Fiedler	D-65396	017	2022/9/8	2023/9/7
LISN R&S	ENV216	101196	2022/5/24	2023/5/23
LISN Schwarzbeck	NNLK 8121	8121-00759	2022/8/18	2023/8/17
		8121-731	2022/5/26	2023/5/25
	NNLK8129	8129229	2022/6/8	2023/6/7
	NSLK 8128	8128-244	2022/11/8	2023/11/7
RF Coaxial Cable Commate	5D-FB	Cable-CO5-01	2022/1/28	2023/1/27
Software BVADT	Cond_V7.3.7.4	N/A	N/A	N/A
Test Receiver R&S	ESR3	102412	2022/12/21	2023/12/20

Notes:

1. The test was performed in Linkou Conduction 5.
2. The VCCI Site Registration No. C-11093.
3. Tested Date: 2023/1/18

4.2 Radiated Emissions up to 1 GHz

Description Manufacturer	Model No.	Serial No.	Calibrated Date	Calibrated Until
ADT. Tower	AT100	0205	N/A	N/A
ADT. Turn Table	TT100	0205	N/A	N/A
Attenuator Mini-Circuits	UNAT-5+	PAD-ST2-01	2022/10/21	2023/10/20
Bi-log Broadband Antenna Schwarzbeck	VULB9168	9168-303	2022/10/25	2023/10/24
Coupling/Dcoupling Network Schwarzbeck	CDNE-M2	00097	2022/6/1	2023/5/31
	CDNE-M3	00091	2022/6/1	2023/5/31
Preamplifier Agilent	8447D	2944A11062	2022/2/16	2023/2/15
Pre_Amplifier EMCI	EMC9135	980711	2022/3/19	2023/3/18
Pre_Amplifier HP	8447D	2944A08313	2022/2/16	2023/2/15
RF Coaxial Cable Pacific	8D-FB	Cable-ST2-01	2022/10/21	2023/10/20
Software BVADT	Radiated_V7.6.15.9.5	N/A	N/A	N/A
TEST RECEIVER R&S	ESCS 30	100276	2022/4/19	2023/4/18
		100292	2022/8/30	2023/8/29

Notes:

1. The test was performed in Linkou Open Site2 , The test site validated date: 2022/7/16 (NSA)
2. The VCCI Site Registration No. R-10237.
3. Tested Date: 2023/1/18

4.3 Electrostatic Discharges (ESD)

Description Manufacturer	Model No.	Serial No.	Calibrated Date	Calibrated Until
ESD Generator EM Test	Dito//DM-150/330//DM- 150/330-rfci	P1315117252/P1317117852	2022/7/7	2023/7/6

Notes:

1. The test was performed in Linkou ESD Room No.03.
2. Tested Date: 2023/2/1

4.4 Radio Frequency Electromagnetic Field (RS)

Description Manufacturer	Model No.	Serial No.	Calibrated Date	Calibrated Until
* Broadband Field Meter Narda	NBM-550	B-0872	2022/3/18	2024/3/17
Amplifier TESEQ	CBA 1G-150	T44220	N/A	N/A
Amplifier TESTQ	AS1860-50	S-5944/1	N/A	N/A
	CBA 3G-050	T44345	N/A	N/A
Audio analyzer R&S	UPV	104565	2022/5/10	2023/5/9
Band pass filter B&K	WH3278	N/A	2022/6/5	2023/6/4
CHANCE MOST Compact Full Anechoic Chamber (7x3x3 m)	N/A	N/A	2023/1/17	2024/1/16
Ear Simulator Telephonometry B&K	4185	2553594	N/A	N/A
Power Meter BOONTON	4232A	94901	2022/6/6	2023/6/5
Power Sensor BOONTON	51011-EMC	32807	2022/6/6	2023/6/5
Pressure-field Microphone B&K	4192	2735408	2022/4/26	2023/4/25
RF Generator TESEQ	ITS 6006	37543	2022/5/10	2023/5/9
RS antenna schwarzbeck mess-elektronik	STLP 9129	9129068	N/A	N/A
Software BVADT	BV ADT_ABMS_ V7.4.3	N/A	N/A	N/A
Software BVADT	RS_V7.6	N/A	N/A	N/A
Two channel microphone conditioning amplifier B&K	2690 A OS2	2645274	2022/6/5	2023/6/4
Wireless Connection Tester R&S	CMW270	101075	2022/4/18	2023/4/17

Notes:

- * The calibration interval of the above test instruments is 24 months and the calibrations are traceable to NML/ROC and NIST/USA
- The test was performed in Linkou RS Room No.1.
- Tested Date: 2023/1/30

4.5 Fast Transients Common Mode (EFT)

Description Manufacturer	Model No.	Serial No.	Calibrated Date	Calibrated Until
Surge&EFT Generators TESEQ	NSG 3060	1572	2022/4/18	2023/4/17

Notes:

- The test was performed in Linkou EMS Room No.02.
- Tested Date: 2023/1/31

4.6 Surges

Description Manufacturer	Model No.	Serial No.	Calibrated Date	Calibrated Until
CDN for Unshielded Unsymmetrical Signal & Data Lines TESEQ	CDN117	40144	2022/8/23	2023/8/22
Coupling Decoupling Network EMC-Partner	CDN-UTP8	045	2022/8/2	2023/8/1
Coupling Decoupling Network TESEQ	CDN HSS-2	41009	2022/4/18	2023/4/17
Surge Coupling Decoupling Network TESEQ	CDN 118-T8	40386	2022/8/23	2023/8/22
Surge&EFT Generators TESEQ	NSG 3060	1572	2022/4/18	2023/4/17

Notes:

1. The test was performed in Linkou EMS Room No.02.
2. Tested Date: 2023/1/31

4.7 Radio Frequency Common Mode (CS)

Description Manufacturer	Model No.	Serial No.	Calibrated Date	Calibrated Until
Amplifier AR	75A250AM1	306331	N/A	N/A
Audio analyzer R&S	UPV	104565	2022/5/10	2023/5/9
CDN FCC	FCC-801-M5-50A	100018	2023/1/17	2024/1/16
CDN TESEQ	CDN S200	53490	2022/2/24	2023/2/23
	CDN S400	52115	2022/2/24	2023/2/23
CDN Calibration Kit TESEQ	CDN T8S	29459	2022/2/22	2023/2/21
CDN M2-16Amp FCC	FCC-801-M2-16A	01047	2022/2/23	2023/2/22
Coupling Decoupling Network TESEQ	CDN M432S	56519	2022/2/23	2023/2/22
	CDN S751A	56435	2022/2/21	2023/2/20
		56436	2022/2/22	2023/2/21
	CDN ST08A	56525	2022/2/21	2023/2/20
		56527	2022/2/21	2023/2/20
	CDN T2A-10	54942	2022/2/22	2023/2/21
	CDN T8-10	40376	2022/2/22	2023/2/21
	CDN T8-230	56641	2022/2/22	2023/2/21
		56642	2022/2/22	2023/2/21
		56643	2022/2/22	2023/2/21
CDN T800	34428	2022/2/22	2023/2/21	
CDN T400A	49918	2022/2/23	2023/2/22	
Coupling/Dcoupling Network EM TEST	CDN M1/32A	306508	2022/2/23	2023/2/22
Coupling/Dcoupling Network	CDN M232	37702	2022/2/23	2023/2/22



Description Manufacturer	Model No.	Serial No.	Calibrated Date	Calibrated Until
TESEQ	CDN M332	41256	2022/2/23	2023/2/22
		41258	2022/2/23	2023/2/22
Current Clamp FCC	F-120-9A	361	2022/8/17	2023/8/16
Digital Sweep Function Generator Topward	8120	984801	N/A	N/A
Ear Simulator Telephonometry B&K	4185	2553594	N/A	N/A
FCC EM Injection Clamp FCC	F-203I-23mm	455	N/A	N/A
Mouth Simulator B&K	4227	2630632	N/A	N/A
POWER AMPLIFIER B&K	2716C	2610979	N/A	N/A
Power Meter R & S	NRVD	837794/040	2022/10/18	2023/10/17
Power Sensor R & S	NRV-Z5	837878/039	2022/10/18	2023/10/17
Pressure-field Microphone B&K	4192	2735407	2022/11/15	2023/11/14
SIGNAL GENERATOR R&S	SML03	101364	2022/8/16	2023/8/15
Software BVADT	ABMS_ V7.4.3	N/A	N/A	N/A
Software BVADT	CS_V7.4.2	N/A	N/A	N/A
Two channel microphone conditioning amplifier B&K	2690 OS2	3001996	2022/11/15	2023/11/14
Wireless Connection Tester R&S	CMW270	101075	2022/4/18	2023/4/17

Notes:

1. The test was performed in Linkou CS Room No.1.
2. Tested Date: 2023/1/30

4.8 Power Frequency Magnetic Field (PFMF)

Description Manufacturer	Model No.	Serial No.	Calibrated Date	Calibrated Until
F.W.BELL 4190 Gaussmeter F.W. Bell	4190	0743043	2022/4/13	2023/4/12
Magnetic Field Test System Haefely Trench AG	MAG 100	083794-06	N/A	N/A

Notes:

1. The test was performed in Linkou EMS Room No.1.
2. Tested Date: 2023/1/30

5 Limits of Test Items

5.1 Conducted Emissions from Power Ports

Frequency (MHz)	Class A (dB μ V)		Class B (dB μ V)	
	Quasi-peak	Average	Quasi-peak	Average
0.15 - 0.5	79	66	66 - 56	56 - 46
0.50 - 5.0	73	60	56	46
5.0 - 30.0	73	60	60	50

- Notes: 1. The lower limit shall apply at the transition frequencies.
 2. The limit decreases linearly with the logarithm of the frequency in the range of 0.15 to 0.50 MHz.

5.2 Radiated Emissions up to 1 GHz

Frequency (MHz)	Class A		Class B	
	Quasi-peak (dBuV/m)		Quasi-peak (dBuV/m)	
	at 3m	at 10m	at 3m	at 10m
30 - 230	50	40	40	30
230 - 1000	57	47	47	37

For radiated emissions from FM receivers only (Measurement Facility: OATS/SAC)

Frequency (MHz)	Fundamental (dBuV/m)		Harmonics (dBuV/m)	
	at 3m	at 10m	at 3m	at 10m
30 - 230	60	50	52	42
230 - 300	60	50	52	42
300 - 1000	60	50	56	46

- Notes: 1. The lower limit shall apply at the transition frequencies.
 2. Emission level (dBuV/m) = 20 log Emission level (uV/m).
 3. All emanations from a class A/B digital device or system, including any network of conductors and apparatus connected thereto, shall not exceed the level of field strengths specified above.

5.3 General immunity requirements

For EN 55035

Port	Basic Standard	Test item	Test specification	Performance criteria	
Power input (AC)	IEC 61000-4-4	Fast Transients, Common Mode (EFT)	±1 kV 5/50 ns (Tr/Th) 5 kHz, repetition frequency	B	
	IEC 61000-4-5	Surge	Line to line: ±1 kV, 1.2/50 µs Line to earth: ±2 kV, 1.2/50 µs	B	
	IEC 61000-4-6	Radio Frequency, Common Mode (CS)	0.15-10 MHz, 3 V, 80% AM (1 kHz), 10-30 MHz, 3 V-1V, 80% AM (1 kHz), 30-80 MHz, 1V, 80% AM (1 kHz),	A	
	IEC 61000-4-11	Voltage dips and interruptions (DIP)	Voltage Dips: < 5 % residual voltage, 0.5 cycle 70% residual voltage, 25 cycles (at 50 Hz) Voltage Interruption: < 5 % residual voltage, 250 cycles (at 50 Hz)	B C C	
DC power/ Wired network and Signal/ Control port	IEC 61000-4-4	Fast Transients, Common Mode (EFT)	±0.5 kV 5/50 ns (Tr/Th) 100 kHz, repetition frequency for xDSL port 5 kHz, repetition frequency for other port	B	
	IEC 61000-4-5	Surge	Wired network ports (directly connected to outdoor cables): Symmetrically operated: 10/700 µs w/o primary protectors: ±1.0 kV, or with primary protectors fitted: ±1.0 kV and ±4.0 kV, Coaxial or shielded operated: 1.2/50 µs shield to ground: ±0.5 kV,	C B	
			DC power ports (directly connected to outdoor cables): 1.2/50 µs each individual line to earth, or shield to ground: ±0.5 kV,	B	
	IEC 61000-4-6	Broadband impulse noise disturbances (Applicable only to xDSL ports.)	Radio Frequency, Common Mode (CS)	0.15-10 MHz, 3 V, 80% AM (1 kHz), 10-30 MHz, 3 V-1V, 80% AM (1 kHz), 30-80 MHz, 1V, 80% AM (1 kHz),	A
			Repetitive : Impulse frequency profile : 0.15 – 0.5 MHz, 107 dBuV ; 0.5 – 10 MHz, 107 – 36 dBuV ; 10 – 30 MHz, 36 – 30 dBuV Burst duration : 0.70 ms Burst period : 10 ms (for 50 Hz) At least 2 minutes for each port under test. Isolated : Impulse frequency profile : 0.15 – 30 MHz, 110 dBuV Burst duration : 0.24 ms, 10 ms and 300 ms Isolated impulses : 5 times Interval : at least 60 seconds	A B	

Port	Basic Standard	Test item	Test specification	Performance criteria
Enclosure	IEC 61000-4-2	Electrostatic Discharge (ESD)	±4 kV (contact) ±8 kV (Air)	B
	IEC 61000-4-3	Radio Frequency Electromagnetic Field (RS)	Swept Frequency Test: 80 to 1000(MHz), 3 V/m, 80 % AM (1 kHz) Spot Frequency Test: 1800, 2600, 3500, 5000 MHz (±1 %), 3 V/m, 80% AM (1 kHz)	A
	IEC 61000-4-8	Power Frequency Magnetic Field (PFMF)	1 A/m, 50 Hz	A

6.2 Radiated Emissions up to 1 GHz

- For the table-top EUT is placed on a 0.8 meter to the top of rotating table; for the floor standing EUT shall be insulated (by insulation of maximum thickness of 150 mm) from the horizontal reference ground plane. The rotating table is rotated 360 degrees to determine the position of the highest radiation. If the equipment requires a dedicated ground connection, this shall be provided and bonded to the RGP.
- The EUT is set 10 meters away from the interference-receiving antenna, which is mounted on the top of a variable-height antenna tower.
- The antenna is a broadband antenna, and its height is varied from one meter to four meters above the ground to determine the maximum value of the field strength. Both horizontal and vertical polarizations of the antenna are set to make the measurement.
- For each suspected emission, the EUT is arranged to its worst case and then the antenna is tuned to heights from 1 m to 4 m and the rotatable table was turned from 0 degrees to 360 degrees to find the maximum reading.
- The test-receiver system is set to quasi-peak detect function and specified bandwidth with maximum hold mode when the test frequency is up to 1 GHz.

Note: The resolution bandwidth and video bandwidth of test receiver/spectrum analyzer is 120kHz for quasi-peak detection (QP) at frequency up to 1GHz.

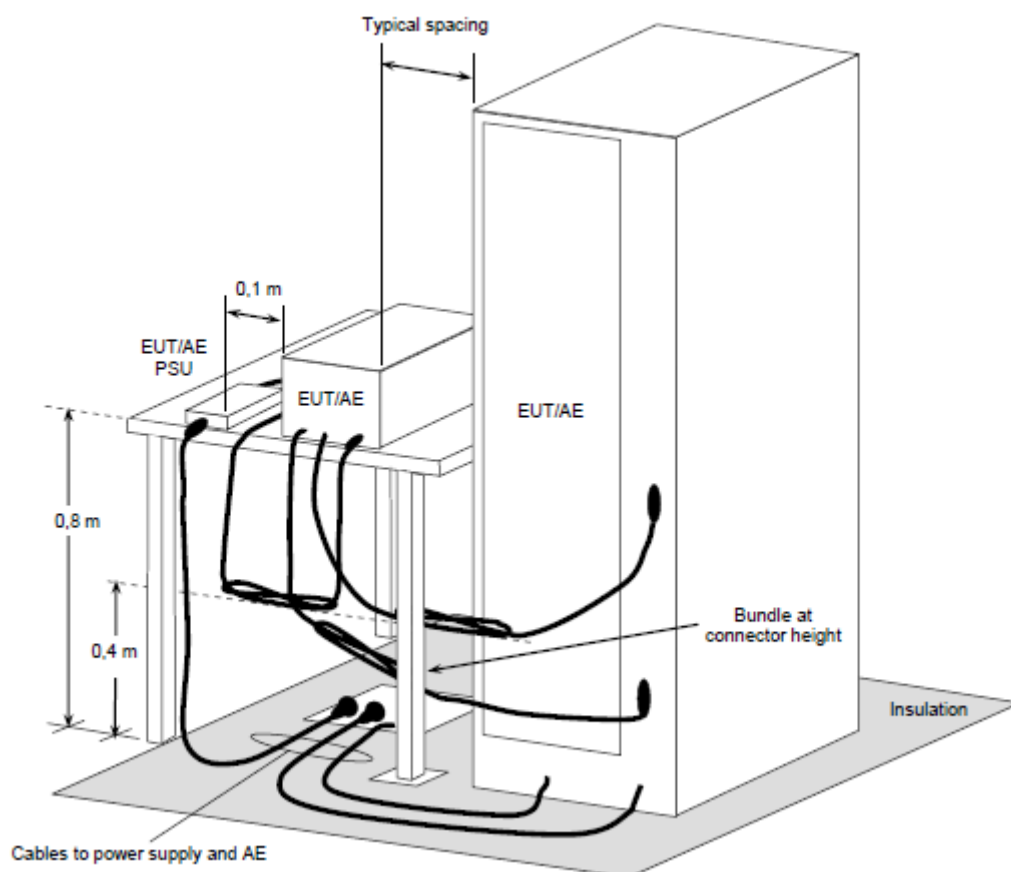

For the actual test configuration, please refer to the related Item – Photographs of the Test Configuration.

6.3 Electrostatic Discharges (ESD)

Discharge Impedance:	330 ohm / 150 pF
Number of Discharge:	Air – Direct: 10 discharges per location (each polarity) Contact – Direct & Indirect: 10 discharges per location (each polarity)
Discharge Period:	1-second minimum

The basic test procedure was in accordance with EN/IEC 61000-4-2:

- a. Electrostatic discharges were applied only to those points and surfaces of the EUT that are accessible to users during normal operation.
- b. The test was performed with at least ten single discharges on the pre-selected points in the most sensitive polarity.
- c. The time interval between two successive single discharges was at least 1 second.
- d. The ESD generator was held perpendicularly to the surface to which the discharge was applied and the return cable was at least 0.2 meters from the EUT.
- e. Contact discharges were applied to the non-insulating coating, with the pointed tip of the generator penetrating the coating and contacting the conducting substrate.
- f. Air discharges were applied with the round discharge tip of the discharge electrode approaching the EUT as fast as possible (without causing mechanical damage) to touch the EUT. After each discharge, the ESD generator was removed from the EUT and re-triggered for a new single discharge. The test was repeated until all discharges were complete.
- g. At least ten single discharges (in the most sensitive polarity) were applied to the **Horizontal Coupling Plane** at points on each side of the EUT. The ESD generator was positioned at a distance of 0.1 meters from the EUT with the discharge electrode touching the **HCP**.
- h. At least ten single discharges (in the most sensitive polarity) were applied to the center of one vertical edge of the **Vertical Coupling Plane** in sufficiently different positions that the four faces of the EUT were completely illuminated. The **VCP** (dimensions 0.5m x 0.5m) was placed vertically to and 0.1 meters from the EUT.

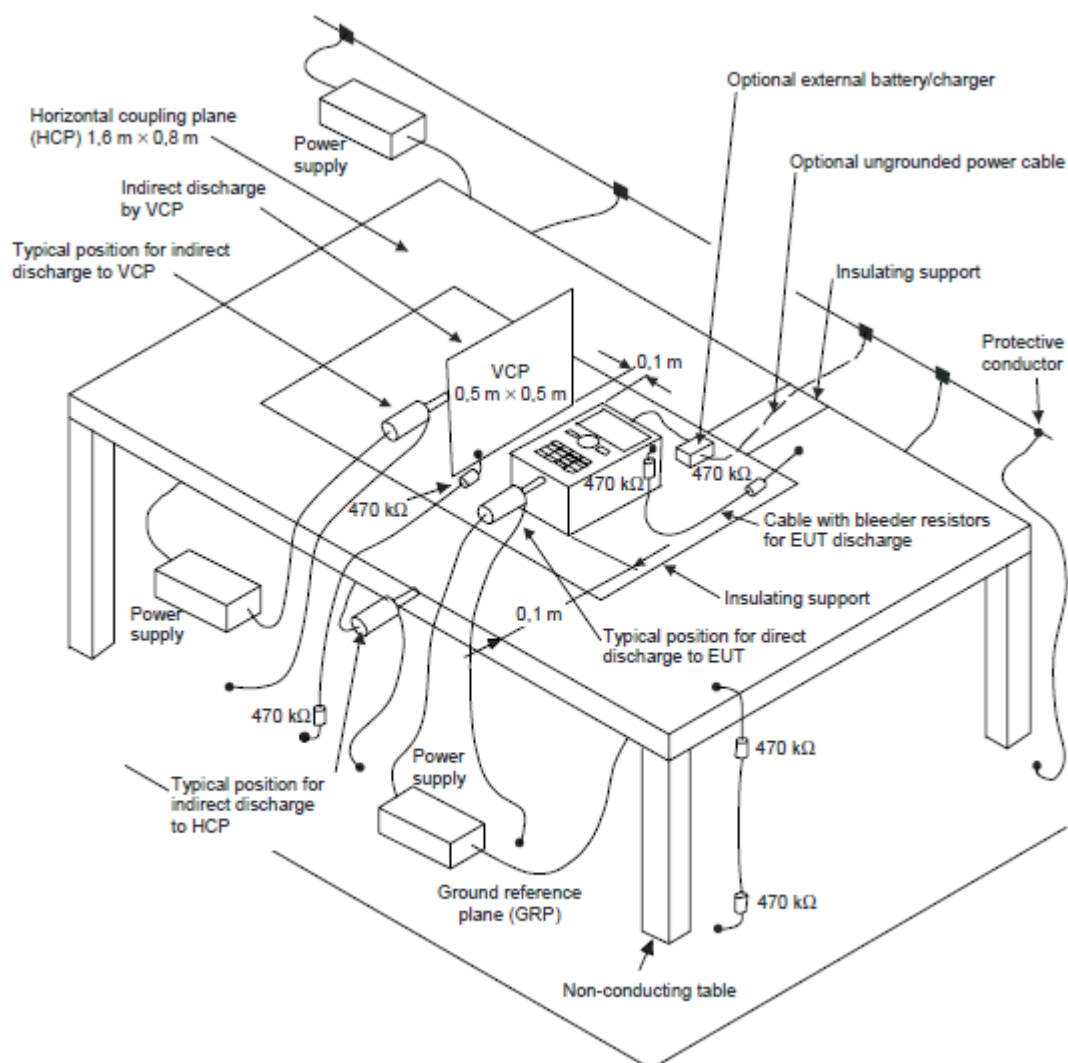

For the actual test configuration, please refer to the related item – Photographs of the Test Configuration.

NOTE:

TABLE-TOP EQUIPMENT

The configuration consisted of a wooden table 0.8 meters high standing on the **Ground Reference Plane**. The **GRP** consisted of a sheet of aluminum at least 0.25mm thick, and 2.5 meters square connected to the protective grounding system. A **Horizontal Coupling Plane** (1.6m x 0.8m) was placed on the table and attached to the **GRP** by means of a cable with 940kΩ total impedance. The equipment under test, was installed in a representative system as described in section 7 of EN/IEC 61000-4-2, and its cables were placed on the **HCP** and isolated by an insulating support of 0.5mm thickness. A distance of 1-meter minimum was provided between the EUT and the walls of the laboratory and any other metallic structure.

FLOOR-STANDING EQUIPMENT

The equipment under test was installed in a representative system as described in section 7 of IEC 61000-4-2, and its cables were isolated from the Ground Reference Plane by an insulating support of 0.1-meter thickness. The GRP consisted of a sheet of aluminum that is at least 0.25mm thick, and 2.5 meters square connected to the protective grounding system and extended at least 0.5 m.

6.4 Radio Frequency Electromagnetic Field (RS)

Modulation:	1kHz Sine Wave, 80%, AM Modulation
Frequency Step:	1 % of preceding frequency value
Dwell Time:	3 seconds

The test procedure was in accordance with EN/IEC 61000-4-3.

- The testing was performed in a modified semi-anechoic chamber.
- The frequency range shall be swept, with the signal 80% amplitude modulated with a 1kHz sine wave.
- The test was performed with the EUT exposed to both vertically and horizontally polarized fields on each of the four sides.

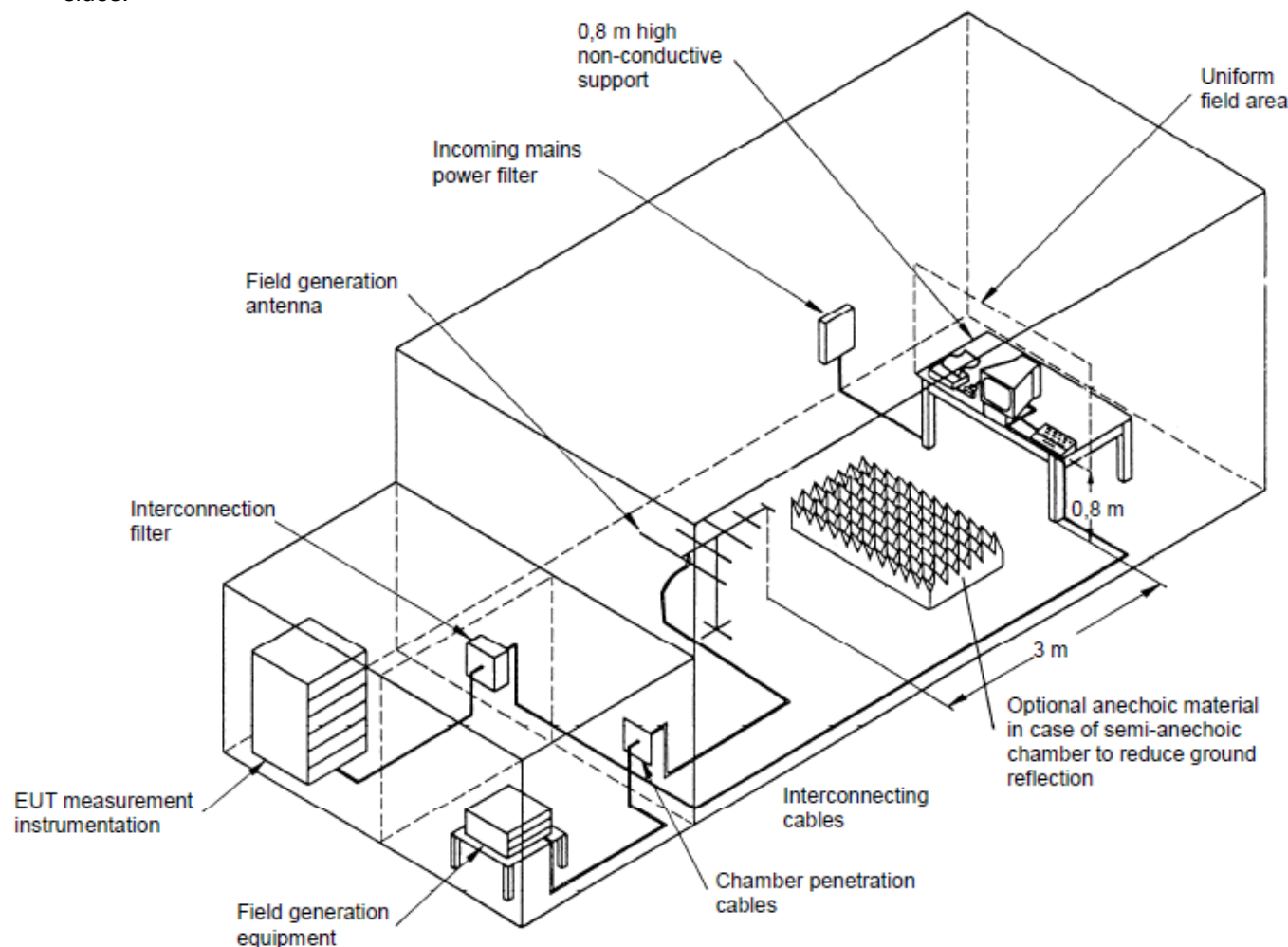

For the actual test configuration, please refer to the related item – Photographs of the Test Configuration.

NOTE:

TABLETOP EQUIPMENT

The EUT installed in a representative system as described in section 7 of EN/IEC 61000-4-3 was placed on a non-conductive table 0.8 meters in height. The system under test was connected to the power and signal wire according to relevant installation instructions.

FLOOR STANDING EQUIPMENT

The EUT installed in a representative system as described in section 7 of EN/IEC 61000-4-3 was placed on a non-conductive wood support 0.1 meters in height. The system under test was connected to the power and signal wire according to relevant installation instructions.

6.5 Fast Transients Common Mode (EFT)

Impulse Repetition Frequency:	xDSL telecommunication port: 100kHz others: 5kHz
Impulse Wave Shape:	5/50 ns
Burst Duration:	0.75 ms for 100kHz Repetition Frequency 15 ms for 5kHz Repetition Frequency
Burst Period:	300 ms
Test Duration:	1 min.

- Both positive and negative polarity discharges were applied.
- The distance between any coupling devices and the EUT should be 0.5 m for table-top equipment testing, and 1.0 m for floor standing equipment.
- The duration time of each test sequential was 1 minute.
- The transient/burst waveform was in accordance with EN/IEC 61000-4-4, 5/50 ns.

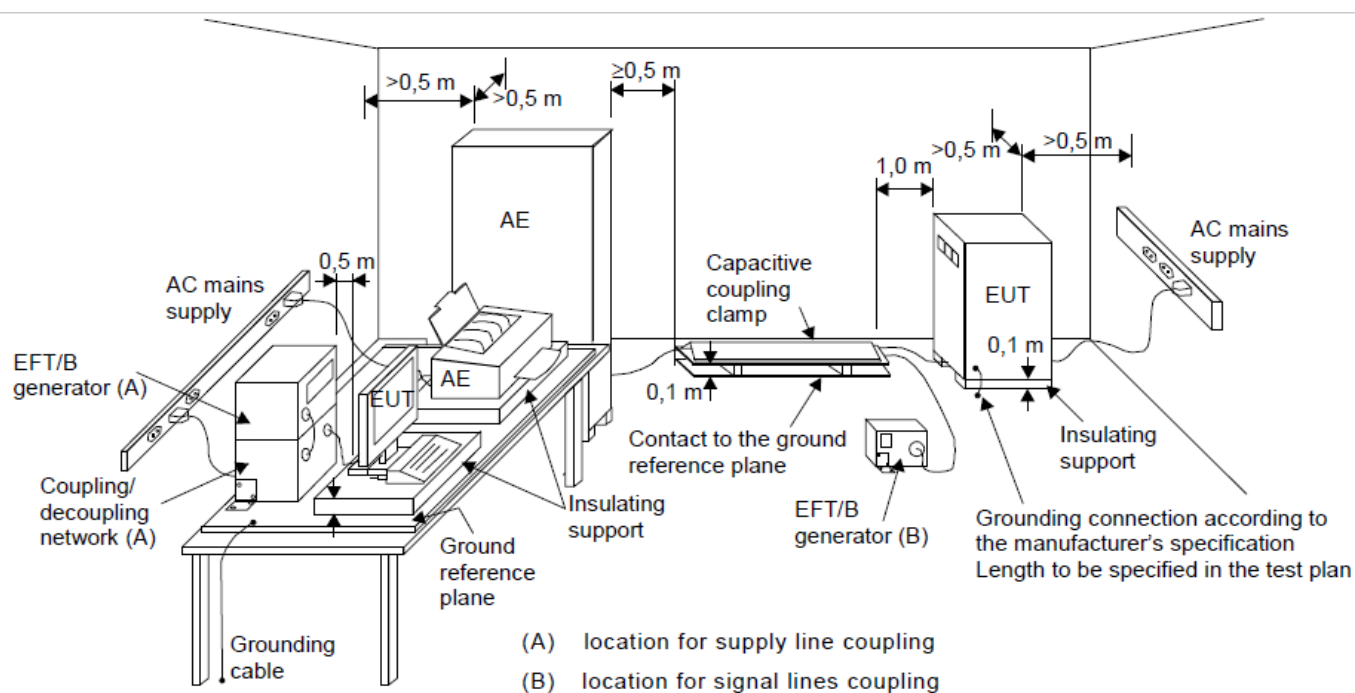

For the actual test configuration, please refer to the related item – Photographs of the Test Configuration.

6.6 Surges

Wave-Shape:	Wired network ports (direct to outdoor cables): Symmetrically operated: 10/700 μ s Open Circuit Voltage 5/320 μ s Short Circuit Current Non-symmetrically operated: 1.2/50 μ s Open Circuit Voltage 8/20 μ s Short Circuit Current Shielded cables (direct to outdoor cables): 1.2/50 μ s Open Circuit Voltage 8/20 μ s Short Circuit Current Wired network ports (indoor cables, longer than 30m): 1.2/50 μ s Open Circuit Voltage 8/20 μ s Short Circuit Current Input DC power port (direct to outdoor cables): 1.2/50 μ s Open Circuit Voltage 8/20 μ s Short Circuit Current Input AC power port: 1.2/50 μ s Open Circuit Voltage 8/20 μ s Short Circuit Current
Pulse Repetition Rate:	20 sec.
Number of Tests:	5 positive and 5 negative at selected points

a. EUT Power ports:

The surge shall be applied to the EUT power supply terminals via the capacitive coupling network. Decoupling networks are required in order to avoid possible adverse effects on equipment not under test that may be powered by the same lines and to provide sufficient decoupling impedance to the surge wave. The power cord between the EUT and the coupling network shall not exceed 2 meters in length.

For double-insulated products without PE or external earth connections, the test shall be done in a similar way as for grounded products but without adding any additional external grounded connections. If there are no other possible connections to earth, line-to-ground tests may be omitted.

b. Wired network ports

- Unshielded unsymmetrical interconnection lines:

The coupling / decoupling networks shall not influence the specified functional conditions of the EUT. The interconnection line between the EUT and the coupling network shall not exceed 2 meters in length.

No line-to-ground surges are applied for double-insulated products (i.e. products without any dedicated earth terminal).

- Unshielded symmetrical interconnection lines:

For symmetrical interconnection lines and high-speed interconnection lines, the CDN shall be selected to match the number of lines/pairs existing the cable. If coupling arrestors are use, test levels below the ignition point of the coupling arrestor cannot be specified.

The interconnection line between the EUT and the coupling/decoupling networks shall not exceed 2 meters in length.

In order to avoid the coupling and decoupling capacitors having a filtering effect on the data transfer, a balanced high frequency design associating the coupling capacitors with coupling chokes is required. Where normal functioning of high speed communications lines cannot be achieved because of the impact of the CDN on the EUT, product committees should specify appropriate operation or that no surge immunity test is required.

- Shielded lines:

The EUT is isolated from ground and the surge is applied to its metallic enclosure; the termination (or auxiliary equipment) at the port(s) under test is grounded. This test applies to equipment with one or more shielded cables.

The length of the cable between the port(s) under test and the device attached to the other end of the cable (AE in Figure 12) shall be:

- 20 m (preferred length) or,
- the shortest length over 10 m, where the manufacturer provides pre-assembled cables used in actual installations.

No test shall be required for cables which according to the manufacturer's specification are ≤ 10 m.

Rules for application of the surge to shielded lines:

- a) Shields grounded at both ends:
– the test shall be carried out.

The test level is applied on shields with a 2Ω generator source impedance and with the $18 \mu\text{F}$ capacitor.

- b) Shields grounded at one end:
– the test shall be carried out according to unshielded unsymmetrical interconnection lines or unshielded symmetrical interconnection lines because the shield does not provide any protection against surges induced by magnetic fields.

For EUTs which do not have metallic enclosures, the surge is applied directly to the shielded cable at the EUT side.

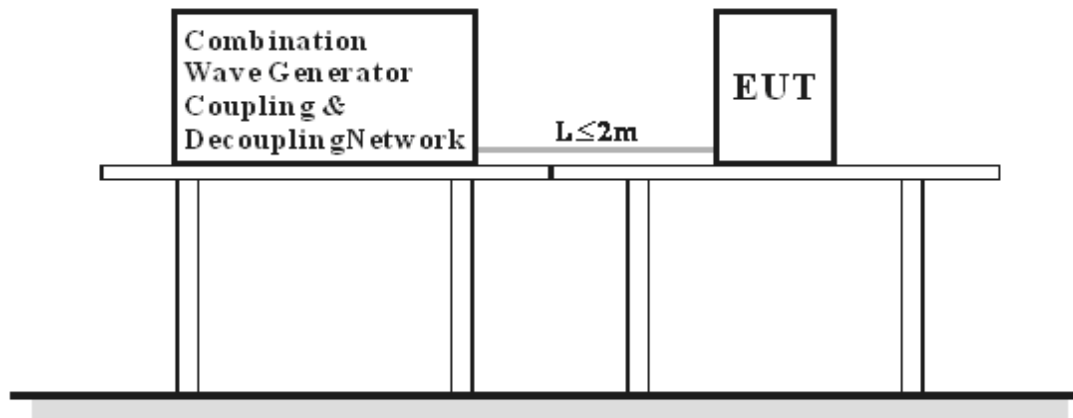

For the actual test configuration, please refer to the related item – Photographs of the Test Configuration.

6.7 Radio Frequency Common Mode (CS)

Modulation:	1kHz Sine Wave, 80%, AM Modulation
Frequency Step:	1 % of preceding frequency value
Dwell Time	3 seconds

- The EUT shall be tested within its intended operating and climatic conditions.
- An artificial hand was placed on the hand-held accessory and connected to the ground reference plane.
- One of the CDNs not used for injection was terminated with 50 ohm, providing only one return path. All other CDNs were coupled as decoupling networks.
- The frequency range shall be swept, using the signal level established during the setting process and with a disturbance signal of 80 % amplitude. The signal is modulated with a 1 kHz sine wave, pausing to adjust the RF signal level or the switch coupling devices as necessary. Where the frequency is swept incrementally, the step size shall not exceed 1 % of the preceding frequency value.
- Attempts should be made to fully exercise the EUT during testing, and to fully interrogate all exercise modes selected for susceptibility.

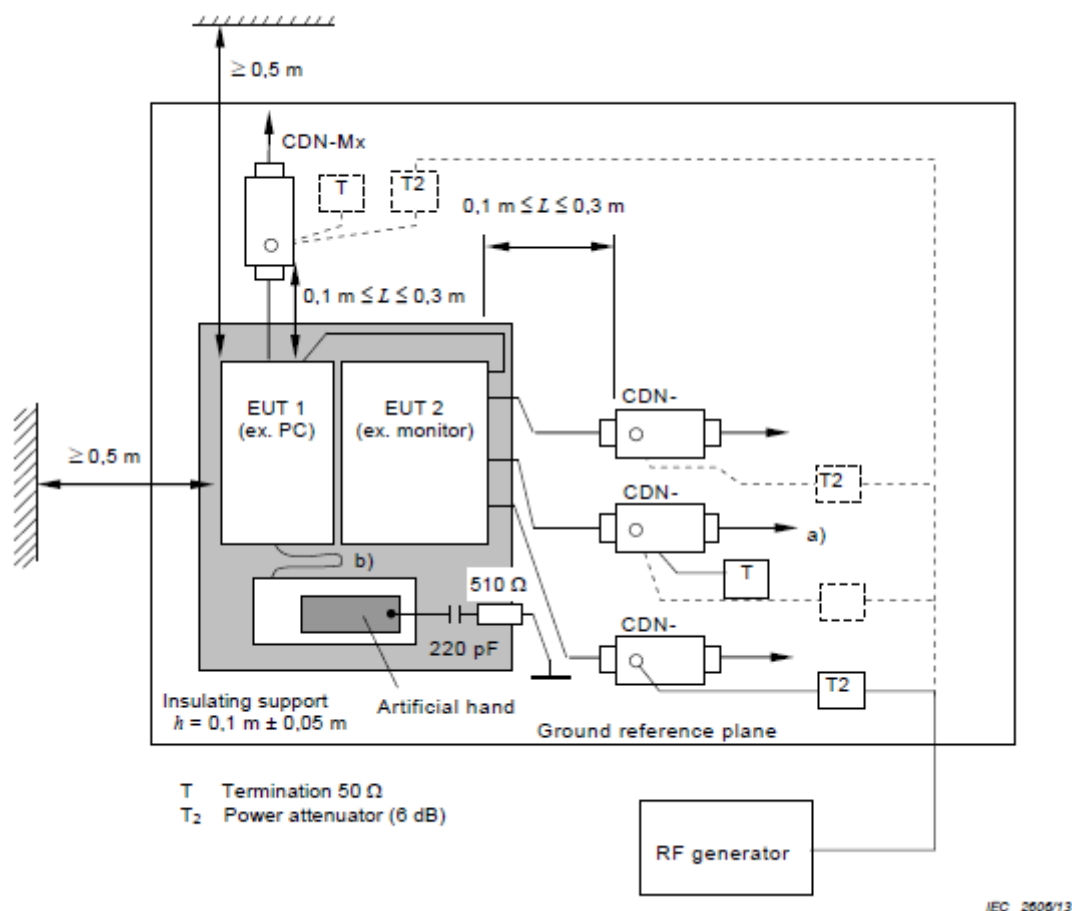

- Note:**
- The EUT clearance from any metallic obstacles shall be at least 0,5 m.
 - Interconnecting cables (≤ 1 m) belonging to the EUT shall remain on the insulating support.
- For the actual test configuration, please refer to the related item – Photographs of the Test Configuration.

Broadband impulse noise disturbances, Repetitive and Isolated (Applicable only to xDSL ports.)

- a. The EUT shall be tested within its intended operating and climatic conditions.
- b. An artificial hand was placed on the hand-held accessory and connected to the ground reference plane.
- c. One of the CDNs not used for injection was terminated with 50 ohm, providing only one return path. All other CDNs were coupled as decoupling networks.
- d. For the repetitive impulse test the disturbance shall be applied for a period of at least 2 minutes for each port under test.
- e. For the isolated impulse test a minimum of 5 isolated impulses shall be applied with an interval of at least 60 seconds between successive impulses.
- f. Attempts should be made to fully exercise the EUT during testing, and to fully interrogate all exercise modes selected for susceptibility.

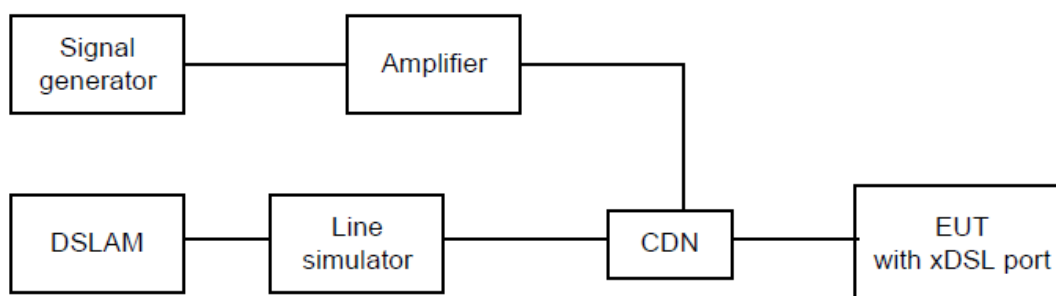

Example schematic of the broadband impulsive conducted disturbances test setup

For the actual test configuration, please refer to the related item – Photographs of the Test Configuration.

6.8 Power Frequency Magnetic Field (PFMF)

Observation Time:	1 minute
Inductance Coil:	Rectangular coil, 1 m x 1 m (L x W) or 2.6 m x 1 m (L x W)

- The equipment is configured and connected to satisfy its functional requirements.
- The power supply, input and output circuits shall be connected to the sources of power supply, control and signal.
- The cables supplied or recommended by the equipment manufacturer shall be used. 1 meter of all cables used shall be exposed to the magnetic field.

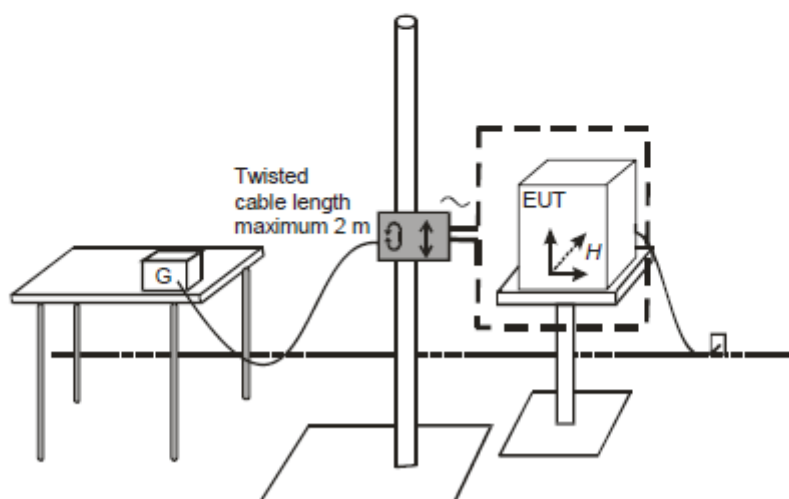
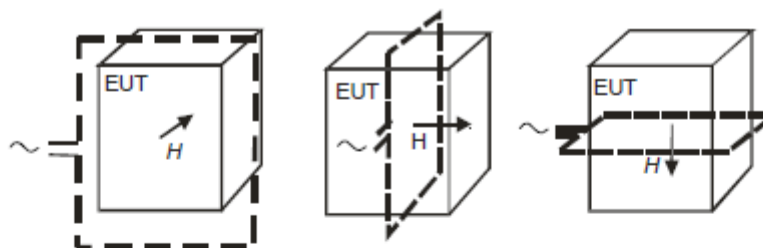

For the actual test configuration, please refer to the related item – Photographs of the Test Configuration.

7 Test Results of Test Item

7.1 Conducted Emissions from Power Ports

Mode A

Frequency Range	150 kHz ~ 30 MHz	Detector Function & Resolution Bandwidth	Quasi-Peak (QP) / Average (AV), 9kHz
Input Power	5 Vdc	Environmental Conditions	18°C, 75% RH
Tested by	Chin-Wen Wang		

Phase Of Power : Positive (+)										
No	Frequency (MHz)	Correction Factor (dB)	Reading Value (dBuV)		Emission Level (dBuV)		Limit (dBuV)		Margin (dB)	
			Q.P.	AV.	Q.P.	AV.	Q.P.	AV.	Q.P.	AV.
1	0.20890	9.92	15.30	15.19	25.22	25.11	79.00	66.00	-53.78	-40.89
2	0.27691	9.92	14.06	11.71	23.98	21.63	79.00	66.00	-55.02	-44.37
3	0.75200	9.93	20.13	13.47	30.06	23.40	73.00	60.00	-42.94	-36.60
4	9.98000	10.18	19.28	18.61	29.46	28.79	73.00	60.00	-43.54	-31.21
5	20.70400	10.33	14.57	13.05	24.90	23.38	73.00	60.00	-48.10	-36.62
6	29.73600	10.40	17.52	13.12	27.92	23.52	73.00	60.00	-45.08	-36.48

Remarks:

1. Q.P. and AV. are abbreviations of quasi-peak and average individually.
2. The emission levels of other frequencies were very low against the limit.
3. Margin value = Emission level – Limit value
4. Correction factor = Insertion loss + Cable loss
5. Emission Level = Correction Factor + Reading Value

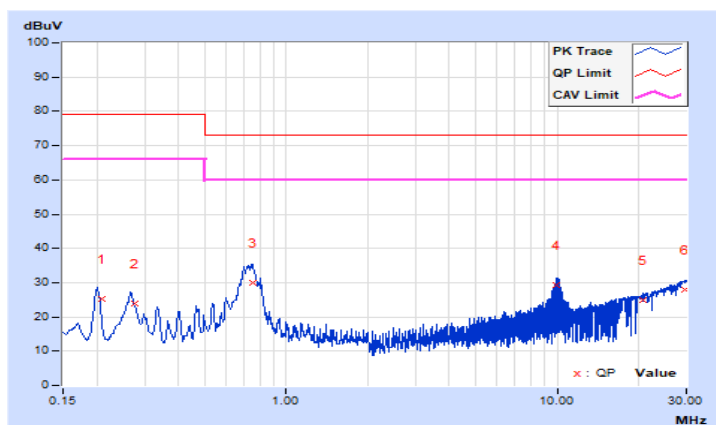

Frequency Range	150 kHz ~ 30 MHz	Detector Function & Resolution Bandwidth	Quasi-Peak (QP) / Average (AV), 9kHz
Input Power	5 Vdc	Environmental Conditions	18°C, 75% RH
Tested by	Chin-Wen Wang		

Phase Of Power : Negative (-)										
No	Frequency (MHz)	Correction Factor (dB)	Reading Value (dBuV)		Emission Level (dBuV)		Limit (dBuV)		Margin (dB)	
			Q.P.	AV.	Q.P.	AV.	Q.P.	AV.	Q.P.	AV.
1	0.15000	9.91	17.22	17.20	27.13	27.11	79.00	66.00	-51.87	-38.89
2	0.22382	9.92	14.81	14.80	24.73	24.72	79.00	66.00	-54.27	-41.28
3	0.73200	9.94	20.59	13.63	30.53	23.57	73.00	60.00	-42.47	-36.43
4	10.37200	10.20	4.02	2.80	14.22	13.00	73.00	60.00	-58.78	-47.00
5	21.00800	10.36	12.04	4.95	22.40	15.31	73.00	60.00	-50.60	-44.69
6	29.75200	10.39	18.85	16.02	29.24	26.41	73.00	60.00	-43.76	-33.59

Remarks:

1. Q.P. and AV. are abbreviations of quasi-peak and average individually.
2. The emission levels of other frequencies were very low against the limit.
3. Margin value = Emission level – Limit value
4. Correction factor = Insertion loss + Cable loss
5. Emission Level = Correction Factor + Reading Value

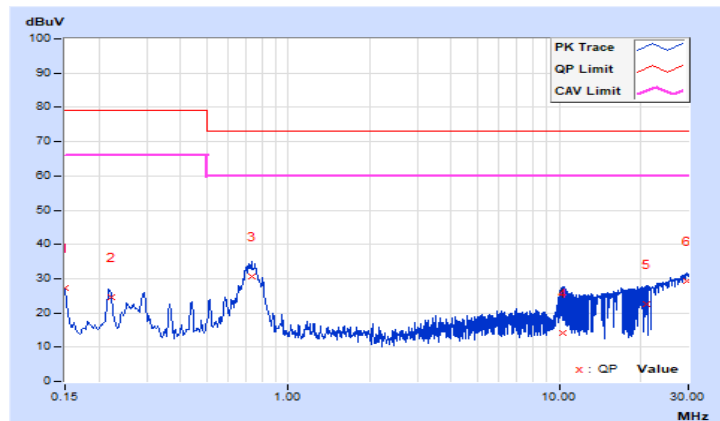

Mode B

Frequency Range	150 kHz ~ 30 MHz	Detector Function & Resolution Bandwidth	Quasi-Peak (QP) / Average (AV), 9kHz
Input Power	12 Vdc	Environmental Conditions	18°C, 75% RH
Tested by	Chin-Wen Wang		

Phase Of Power : Positive (+)										
No	Frequency (MHz)	Correction Factor (dB)	Reading Value (dBuV)		Emission Level (dBuV)		Limit (dBuV)		Margin (dB)	
			Q.P.	AV.	Q.P.	AV.	Q.P.	AV.	Q.P.	AV.
1	0.16579	9.92	16.15	16.14	26.07	26.06	79.00	66.00	-52.93	-39.94
2	0.25710	9.92	14.43	12.39	24.35	22.31	79.00	66.00	-54.65	-43.69
3	0.72000	9.93	23.78	17.65	33.71	27.58	73.00	60.00	-39.29	-32.42
4	0.75200	9.93	22.70	15.66	32.63	25.59	73.00	60.00	-40.37	-34.41
5	3.74894	10.00	3.90	1.84	13.90	11.84	73.00	60.00	-59.10	-48.16
6	29.31200	10.39	19.12	16.73	29.51	27.12	73.00	60.00	-43.49	-32.88

Remarks:

1. Q.P. and AV. are abbreviations of quasi-peak and average individually.
2. The emission levels of other frequencies were very low against the limit.
3. Margin value = Emission level – Limit value
4. Correction factor = Insertion loss + Cable loss
5. Emission Level = Correction Factor + Reading Value

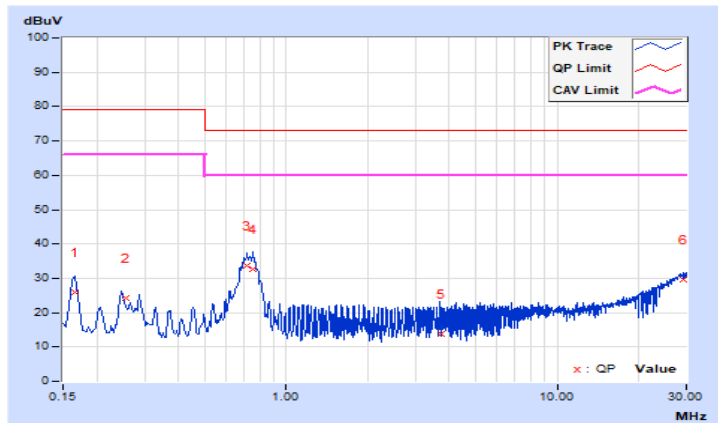

Frequency Range	150 kHz ~ 30 MHz	Detector Function & Resolution Bandwidth	Quasi-Peak (QP) / Average (AV), 9kHz
Input Power	12 Vdc	Environmental Conditions	18°C, 75% RH
Tested by	Chin-Wen Wang		

Phase Of Power : Negative (-)										
No	Frequency (MHz)	Correction Factor (dB)	Reading Value (dBuV)		Emission Level (dBuV)		Limit (dBuV)		Margin (dB)	
			Q.P.	AV.	Q.P.	AV.	Q.P.	AV.	Q.P.	AV.
1	0.15000	9.91	19.64	19.62	29.55	29.53	79.00	66.00	-49.45	-36.47
2	0.26904	9.92	7.54	3.48	17.46	13.40	79.00	66.00	-61.54	-52.60
3	0.70796	9.94	22.61	17.76	32.55	27.70	73.00	60.00	-40.45	-32.30
4	1.65924	9.97	6.85	6.25	16.82	16.22	73.00	60.00	-56.18	-43.78
5	20.48400	10.36	13.61	11.88	23.97	22.24	73.00	60.00	-49.03	-37.76
6	29.76000	10.39	17.76	13.18	28.15	23.57	73.00	60.00	-44.85	-36.43

Remarks:

1. Q.P. and AV. are abbreviations of quasi-peak and average individually.
2. The emission levels of other frequencies were very low against the limit.
3. Margin value = Emission level – Limit value
4. Correction factor = Insertion loss + Cable loss
5. Emission Level = Correction Factor + Reading Value

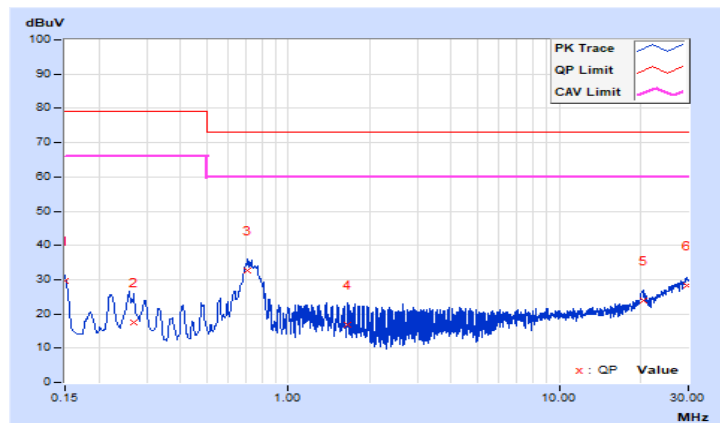

Mode C

Frequency Range	150 kHz ~ 30 MHz	Detector Function & Resolution Bandwidth	Quasi-Peak (QP) / Average (AV), 9kHz
Input Power	12 Vdc	Environmental Conditions	18°C, 75% RH
Tested by	Chin-Wen Wang		

Phase Of Power : Positive (+)										
No	Frequency (MHz)	Correction Factor (dB)	Reading Value (dBuV)		Emission Level (dBuV)		Limit (dBuV)		Margin (dB)	
			Q.P.	AV.	Q.P.	AV.	Q.P.	AV.	Q.P.	AV.
1	0.22152	9.92	14.85	14.83	24.77	24.75	79.00	66.00	-54.23	-41.25
2	0.31179	9.92	17.09	16.57	27.01	26.49	79.00	66.00	-51.99	-39.51
3	0.73200	9.93	23.78	15.99	33.71	25.92	73.00	60.00	-39.29	-34.08
4	1.21706	9.95	16.26	16.23	26.21	26.18	73.00	60.00	-46.79	-33.82
5	1.86802	9.97	15.45	15.43	25.42	25.40	73.00	60.00	-47.58	-34.60
6	29.80000	10.40	17.23	15.02	27.63	25.42	73.00	60.00	-45.37	-34.58

Remarks:

1. Q.P. and AV. are abbreviations of quasi-peak and average individually.
2. The emission levels of other frequencies were very low against the limit.
3. Margin value = Emission level – Limit value
4. Correction factor = Insertion loss + Cable loss
5. Emission Level = Correction Factor + Reading Value

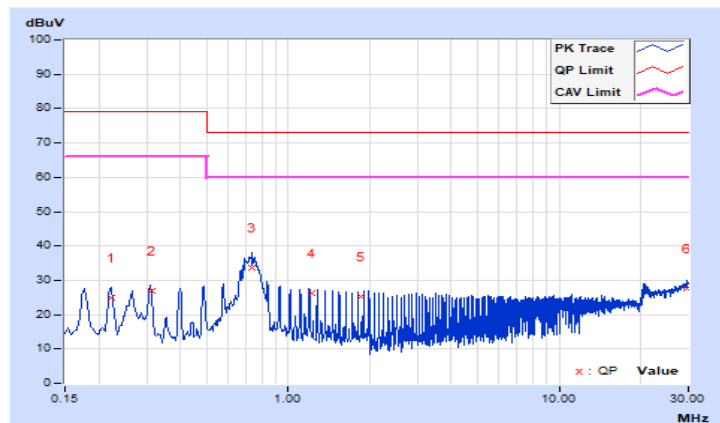

Frequency Range	150 kHz ~ 30 MHz	Detector Function & Resolution Bandwidth	Quasi-Peak (QP) / Average (AV), 9kHz
Input Power	12 Vdc	Environmental Conditions	18°C, 75% RH
Tested by	Chin-Wen Wang		

Phase Of Power : Negative (-)										
No	Frequency (MHz)	Correction Factor (dB)	Reading Value (dBuV)		Emission Level (dBuV)		Limit (dBuV)		Margin (dB)	
			Q.P.	AV.	Q.P.	AV.	Q.P.	AV.	Q.P.	AV.
1	0.18519	9.92	14.24	14.22	24.16	24.14	79.00	66.00	-54.84	-41.86
2	0.26992	9.92	10.60	8.28	20.52	18.20	79.00	66.00	-58.48	-47.80
3	0.71171	9.94	22.05	14.81	31.99	24.75	73.00	60.00	-41.01	-35.25
4	1.25902	9.96	15.51	15.49	25.47	25.45	73.00	60.00	-47.53	-34.55
5	2.00956	9.98	15.83	15.81	25.81	25.79	73.00	60.00	-47.19	-34.21
6	29.82000	10.39	14.64	2.48	25.03	12.87	73.00	60.00	-47.97	-47.13

Remarks:

1. Q.P. and AV. are abbreviations of quasi-peak and average individually.
2. The emission levels of other frequencies were very low against the limit.
3. Margin value = Emission level – Limit value
4. Correction factor = Insertion loss + Cable loss
5. Emission Level = Correction Factor + Reading Value

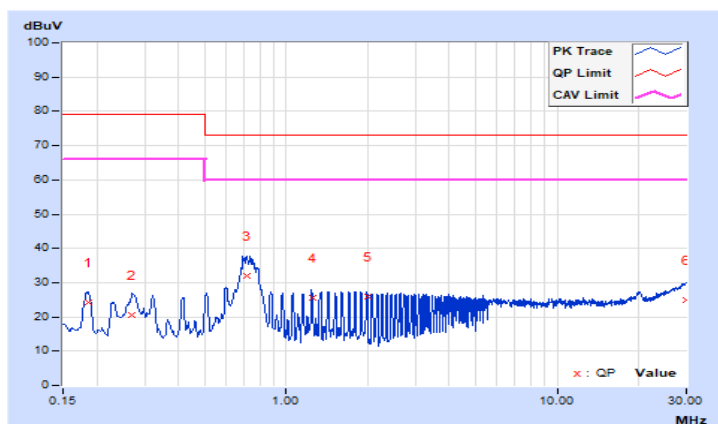

Mode D

Frequency Range	150 kHz ~ 30 MHz	Detector Function & Resolution Bandwidth	Quasi-Peak (QP) / Average (AV), 9kHz
Input Power	24 Vdc	Environmental Conditions	18°C, 75% RH
Tested by	Chin-Wen Wang		

Phase Of Power : Positive (+)										
No	Frequency (MHz)	Correction Factor (dB)	Reading Value (dBuV)		Emission Level (dBuV)		Limit (dBuV)		Margin (dB)	
			Q.P.	AV.	Q.P.	AV.	Q.P.	AV.	Q.P.	AV.
1	0.26780	9.92	12.51	6.98	22.43	16.90	79.00	66.00	-56.57	-49.10
2	0.75200	9.93	21.43	14.31	31.36	24.24	73.00	60.00	-41.64	-35.76
3	3.68800	10.00	11.32	4.00	21.32	14.00	73.00	60.00	-51.68	-46.00
4	4.47146	10.01	12.08	10.48	22.09	20.49	73.00	60.00	-50.91	-39.51
5	16.75200	10.30	12.51	6.05	22.81	16.35	73.00	60.00	-50.19	-43.65
6	26.93640	10.36	16.66	15.22	27.02	25.58	73.00	60.00	-45.98	-34.42

Remarks:

1. Q.P. and AV. are abbreviations of quasi-peak and average individually.
2. The emission levels of other frequencies were very low against the limit.
3. Margin value = Emission level – Limit value
4. Correction factor = Insertion loss + Cable loss
5. Emission Level = Correction Factor + Reading Value

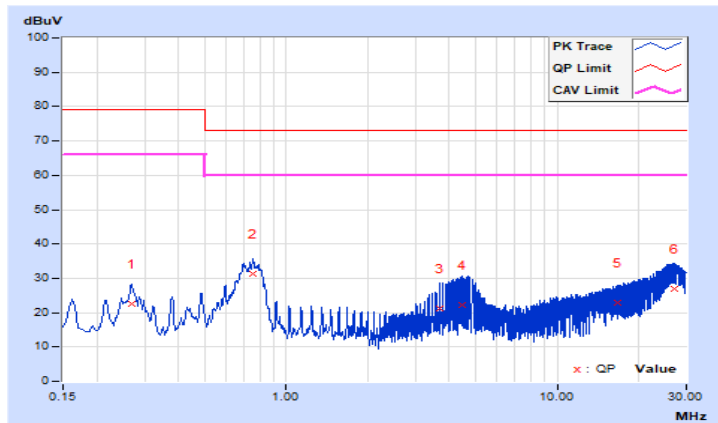

Frequency Range	150 kHz ~ 30 MHz	Detector Function & Resolution Bandwidth	Quasi-Peak (QP) / Average (AV), 9kHz
Input Power	24 Vdc	Environmental Conditions	18°C, 75% RH
Tested by	Chin-Wen Wang		

Phase Of Power : Negative (-)										
No	Frequency (MHz)	Correction Factor (dB)	Reading Value (dBuV)		Emission Level (dBuV)		Limit (dBuV)		Margin (dB)	
			Q.P.	AV.	Q.P.	AV.	Q.P.	AV.	Q.P.	AV.
1	0.26170	9.92	11.51	6.81	21.43	16.73	79.00	66.00	-57.57	-49.27
2	0.73200	9.94	19.39	12.08	29.33	22.02	73.00	60.00	-43.67	-37.98
3	3.65994	10.00	9.11	7.97	19.11	17.97	73.00	60.00	-53.89	-42.03
4	9.84118	10.18	10.94	1.02	21.12	11.20	73.00	60.00	-51.88	-48.80
5	21.53600	10.36	10.61	3.14	20.97	13.50	73.00	60.00	-52.03	-46.50
6	29.89200	10.39	23.29	20.70	33.68	31.09	73.00	60.00	-39.32	-28.91

Remarks:

1. Q.P. and AV. are abbreviations of quasi-peak and average individually.
2. The emission levels of other frequencies were very low against the limit.
3. Margin value = Emission level – Limit value
4. Correction factor = Insertion loss + Cable loss
5. Emission Level = Correction Factor + Reading Value

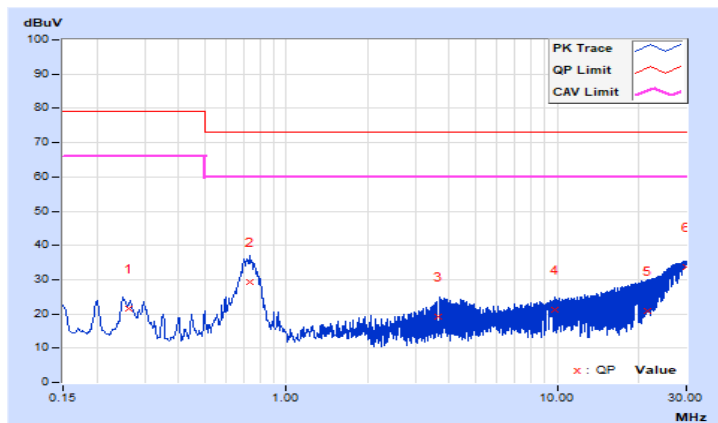

Mode E

Frequency Range	150 kHz ~ 30 MHz	Detector Function & Resolution Bandwidth	Quasi-Peak (QP) / Average (AV), 9kHz
Input Power	24 Vdc	Environmental Conditions	18°C, 75% RH
Tested by	Chin-Wen Wang		

Phase Of Power : Positive (+)										
No	Frequency (MHz)	Correction Factor (dB)	Reading Value (dBuV)		Emission Level (dBuV)		Limit (dBuV)		Margin (dB)	
			Q.P.	AV.	Q.P.	AV.	Q.P.	AV.	Q.P.	AV.
1	0.26582	9.92	15.22	9.77	25.14	19.69	79.00	66.00	-53.86	-46.31
2	0.68800	9.93	19.60	13.84	29.53	23.77	73.00	60.00	-43.47	-36.23
3	0.75200	9.93	21.51	14.71	31.44	24.64	73.00	60.00	-41.56	-35.36
4	1.21098	9.95	12.19	11.74	22.14	21.69	73.00	60.00	-50.86	-38.31
5	10.32800	10.19	13.62	10.17	23.81	20.36	73.00	60.00	-49.19	-39.64
6	27.78400	10.37	17.92	15.19	28.29	25.56	73.00	60.00	-44.71	-34.44

Remarks:

1. Q.P. and AV. are abbreviations of quasi-peak and average individually.
2. The emission levels of other frequencies were very low against the limit.
3. Margin value = Emission level – Limit value
4. Correction factor = Insertion loss + Cable loss
5. Emission Level = Correction Factor + Reading Value

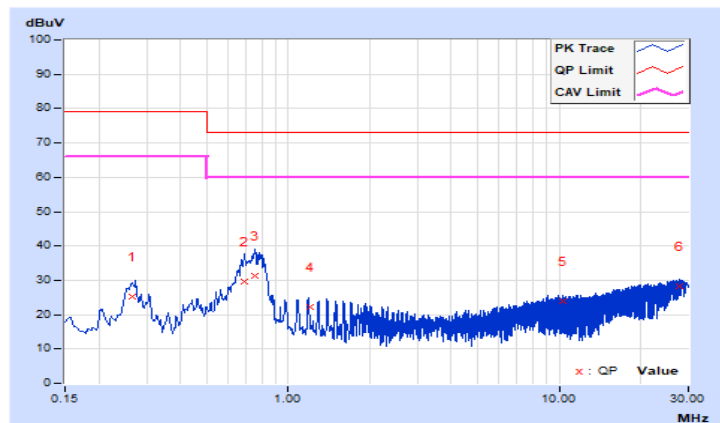

Frequency Range	150 kHz ~ 30 MHz	Detector Function & Resolution Bandwidth	Quasi-Peak (QP) / Average (AV), 9kHz
Input Power	24 Vdc	Environmental Conditions	18°C, 75% RH
Tested by	Chin-Wen Wang		

Phase Of Power : Negative (-)										
No	Frequency (MHz)	Correction Factor (dB)	Reading Value (dBuV)		Emission Level (dBuV)		Limit (dBuV)		Margin (dB)	
			Q.P.	AV.	Q.P.	AV.	Q.P.	AV.	Q.P.	AV.
1	0.26838	9.92	15.41	9.34	25.33	19.26	79.00	66.00	-53.67	-46.74
2	0.70000	9.94	18.03	12.63	27.97	22.57	73.00	60.00	-45.03	-37.43
3	0.77200	9.94	20.23	13.26	30.17	23.20	73.00	60.00	-42.83	-36.80
4	1.16467	9.95	14.59	14.46	24.54	24.41	73.00	60.00	-48.46	-35.59
5	1.58186	9.97	14.65	14.64	24.62	24.61	73.00	60.00	-48.38	-35.39
6	29.85200	10.39	21.96	16.05	32.35	26.44	73.00	60.00	-40.65	-33.56

Remarks:

1. Q.P. and AV. are abbreviations of quasi-peak and average individually.
2. The emission levels of other frequencies were very low against the limit.
3. Margin value = Emission level – Limit value
4. Correction factor = Insertion loss + Cable loss
5. Emission Level = Correction Factor + Reading Value

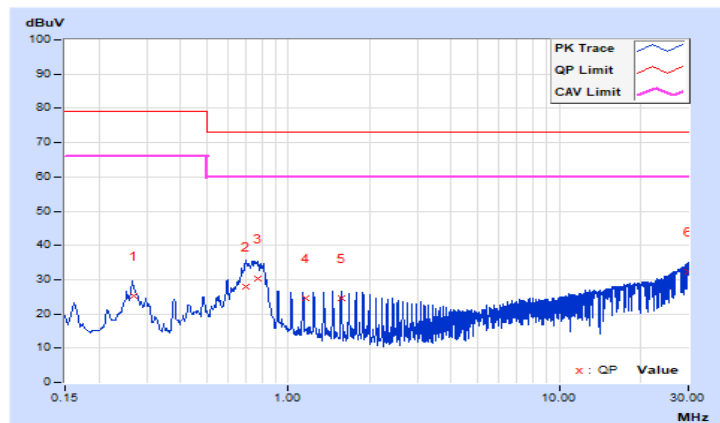

7.2 Radiated Emissions up to 1 GHz

Mode A

Frequency Range	30 MHz ~ 1 GHz	Detector Function & Resolution Bandwidth	Quasi-Peak (QP), 120 kHz
Input Power	5 Vdc	Environmental Conditions	20°C, 70% RH
Tested By	Ed. Lin		

Antenna Polarity & Test Distance : Horizontal at 10 m								
No	Frequency (MHz)	Emission Level (dBuV/m)	Limit (dBuV/m)	Margin (dB)	Antenna Height (m)	Table Angle (Degree)	Raw Value (dBuV)	Correction Factor (dB/m)
1	42.76	24.44 QP	40.00	-15.56	3.99 H	93	33.25	-8.81
2	64.80	24.86 QP	40.00	-15.14	3.99 H	148	34.65	-9.79
3	116.84	25.07 QP	40.00	-14.93	3.99 H	0	35.68	-10.61
4	154.97	26.03 QP	40.00	-13.97	3.99 H	0	33.88	-7.85
5	178.46	22.31 QP	40.00	-17.69	3.99 H	0	31.28	-8.97
6	218.41	27.80 QP	40.00	-12.20	3.99 H	0	38.16	-10.36

Remarks:

1. Emission Level(dBuV/m) = Raw Value(dBuV) + Correction Factor(dB/m)
2. Correction Factor(dB/m) = Antenna Factor (dB/m) + Cable Factor (dB)
– Pre-Amplifier Factor (dB)
3. The other emission levels were very low against the limit.
4. Margin value = Emission level – Limit value

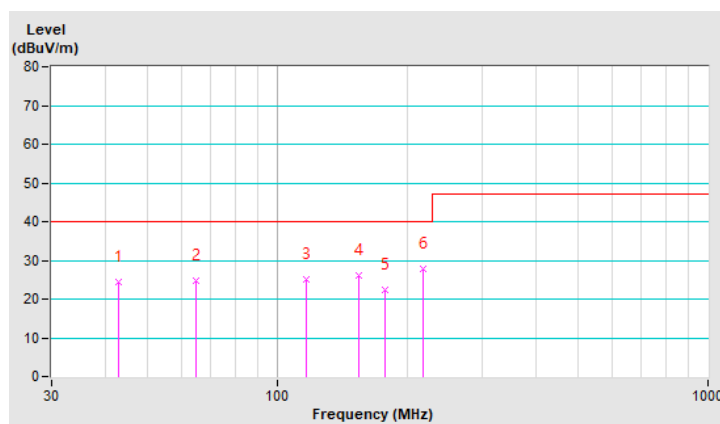

Frequency Range	30 MHz ~ 1 GHz	Detector Function & Resolution Bandwidth	Quasi-Peak (QP), 120 kHz
Input Power	5 Vdc	Environmental Conditions	20°C, 70% RH
Tested By	Ed. Lin		

Antenna Polarity & Test Distance : Vertical at 10 m								
No	Frequency (MHz)	Emission Level (dBuV/m)	Limit (dBuV/m)	Margin (dB)	Antenna Height (m)	Table Angle (Degree)	Raw Value (dBuV)	Correction Factor (dB/m)
1	52.62	24.56 QP	40.00	-15.44	1.00 V	226	33.06	-8.50
2	80.03	26.45 QP	40.00	-13.55	1.00 V	71	39.69	-13.24
3	102.25	26.42 QP	40.00	-13.58	1.00 V	204	38.70	-12.28
4	112.88	25.36 QP	40.00	-14.64	1.00 V	277	36.33	-10.97
5	149.18	25.84 QP	40.00	-14.16	1.00 V	316	33.78	-7.94
6	214.14	20.74 QP	40.00	-19.26	1.00 V	357	31.09	-10.35

Remarks:

1. Emission Level(dBuV/m) = Raw Value(dBuV) + Correction Factor(dB/m)
2. Correction Factor(dB/m) = Antenna Factor (dB/m) + Cable Factor (dB) – Pre-Amplifier Factor (dB)
3. The other emission levels were very low against the limit.
4. Margin value = Emission level – Limit value

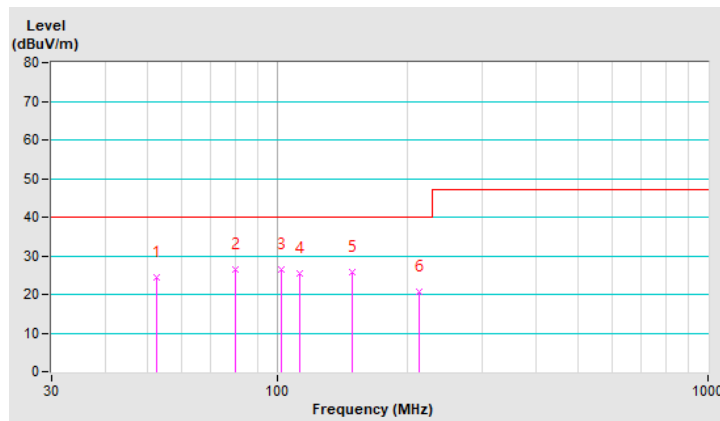

Mode B

Frequency Range	30 MHz ~ 1 GHz	Detector Function & Resolution Bandwidth	Quasi-Peak (QP), 120 kHz
Input Power	12 Vdc	Environmental Conditions	20°C, 70% RH
Tested By	Ed. Lin		

Antenna Polarity & Test Distance : Horizontal at 10 m								
No	Frequency (MHz)	Emission Level (dBuV/m)	Limit (dBuV/m)	Margin (dB)	Antenna Height (m)	Table Angle (Degree)	Raw Value (dBuV)	Correction Factor (dB/m)
1	42.18	28.03 QP	40.00	-11.97	4.00 H	185	36.84	-8.81
2	64.66	28.29 QP	40.00	-11.71	4.00 H	249	38.07	-9.78
3	117.12	26.15 QP	40.00	-13.85	4.00 H	211	36.73	-10.58
4	145.44	24.63 QP	40.00	-15.37	4.00 H	88	32.68	-8.05
5	174.24	23.04 QP	40.00	-16.96	4.00 H	123	31.49	-8.45
6	201.12	17.05 QP	40.00	-22.95	4.00 H	150	27.69	-10.64

Remarks:

1. Emission Level(dBuV/m) = Raw Value(dBuV) + Correction Factor(dB/m)
2. Correction Factor(dB/m) = Antenna Factor (dB/m) + Cable Factor (dB) – Pre-Amplifier Factor (dB)
3. The other emission levels were very low against the limit.
4. Margin value = Emission level – Limit value

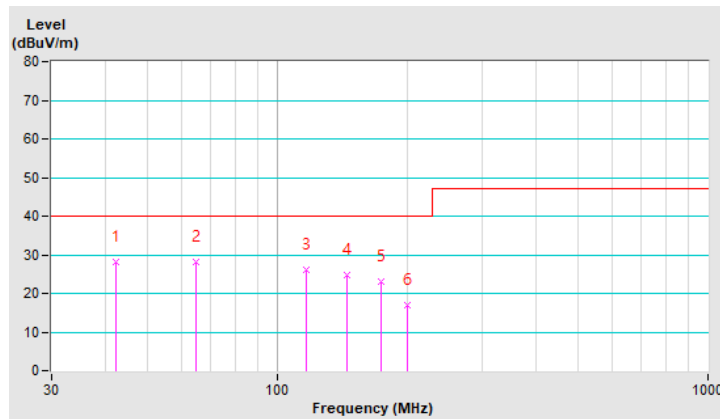

Frequency Range	30 MHz ~ 1 GHz	Detector Function & Resolution Bandwidth	Quasi-Peak (QP), 120 kHz
Input Power	12 Vdc	Environmental Conditions	20°C, 70% RH
Tested By	Ed. Lin		

Antenna Polarity & Test Distance : Vertical at 10 m								
No	Frequency (MHz)	Emission Level (dBuV/m)	Limit (dBuV/m)	Margin (dB)	Antenna Height (m)	Table Angle (Degree)	Raw Value (dBuV)	Correction Factor (dB/m)
1	38.99	26.35 QP	40.00	-13.65	1.00 V	321	35.46	-9.11
2	66.11	26.73 QP	40.00	-13.27	1.00 V	268	36.60	-9.87
3	114.72	19.49 QP	40.00	-20.51	1.00 V	168	30.32	-10.83
4	148.80	25.25 QP	40.00	-14.75	1.00 V	272	33.22	-7.97
5	172.32	22.99 QP	40.00	-17.01	1.00 V	243	31.29	-8.30
6	205.44	20.54 QP	40.00	-19.46	1.00 V	207	31.05	-10.51

Remarks:

1. Emission Level(dBuV/m) = Raw Value(dBuV) + Correction Factor(dB/m)
2. Correction Factor(dB/m) = Antenna Factor (dB/m) + Cable Factor (dB) – Pre-Amplifier Factor (dB)
3. The other emission levels were very low against the limit.
4. Margin value = Emission level – Limit value

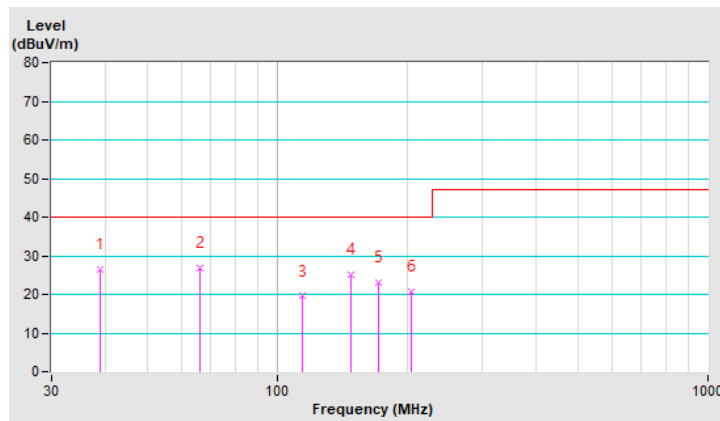

Mode C

Frequency Range	30 MHz ~ 1 GHz	Detector Function & Resolution Bandwidth	Quasi-Peak (QP), 120 kHz
Input Power	12 Vdc	Environmental Conditions	20°C, 70% RH
Tested By	Ed. Lin		

Antenna Polarity & Test Distance : Horizontal at 10 m								
No	Frequency (MHz)	Emission Level (dBuV/m)	Limit (dBuV/m)	Margin (dB)	Antenna Height (m)	Table Angle (Degree)	Raw Value (dBuV)	Correction Factor (dB/m)
1	40.30	27.94 QP	40.00	-12.06	4.00 H	312	37.07	-9.13
2	68.28	27.42 QP	40.00	-12.58	4.00 H	252	37.84	-10.42
3	118.67	22.46 QP	40.00	-17.54	4.00 H	224	32.87	-10.41
4	146.12	24.58 QP	40.00	-15.42	3.92 H	177	32.59	-8.01
5	169.91	23.60 QP	40.00	-16.40	3.57 H	78	31.75	-8.15
6	218.10	20.00 QP	40.00	-20.00	3.37 H	122	30.35	-10.35

Remarks:

1. Emission Level(dBuV/m) = Raw Value(dBuV) + Correction Factor(dB/m)
2. Correction Factor(dB/m) = Antenna Factor (dB/m) + Cable Factor (dB) – Pre-Amplifier Factor (dB)
3. The other emission levels were very low against the limit.
4. Margin value = Emission level – Limit value

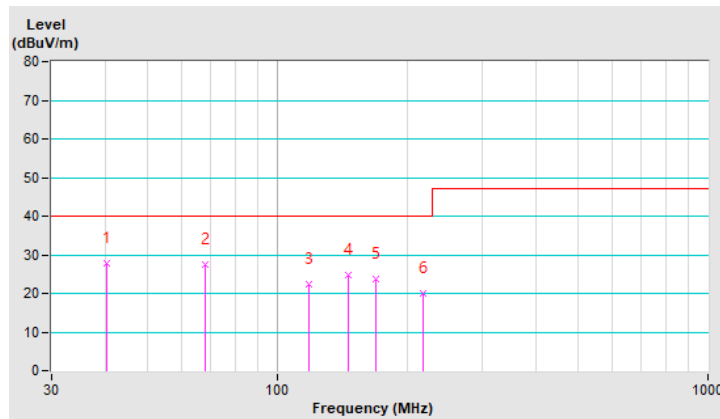

Frequency Range	30 MHz ~ 1 GHz	Detector Function & Resolution Bandwidth	Quasi-Peak (QP), 120 kHz
Input Power	12 Vdc	Environmental Conditions	20°C, 70% RH
Tested By	Ed. Lin		

Antenna Polarity & Test Distance : Vertical at 10 m								
No	Frequency (MHz)	Emission Level (dBuV/m)	Limit (dBuV/m)	Margin (dB)	Antenna Height (m)	Table Angle (Degree)	Raw Value (dBuV)	Correction Factor (dB/m)
1	43.77	28.64 QP	40.00	-11.36	1.00 V	289	37.38	-8.74
2	87.13	28.38 QP	40.00	-11.62	1.00 V	169	42.67	-14.29
3	103.60	26.09 QP	40.00	-13.91	1.00 V	234	38.09	-12.00
4	148.87	24.51 QP	40.00	-15.49	1.00 V	302	32.47	-7.96
5	176.01	19.05 QP	40.00	-20.95	1.00 V	245	27.69	-8.64
6	225.43	24.08 QP	40.00	-15.92	1.00 V	187	34.42	-10.34

Remarks:

1. Emission Level(dBuV/m) = Raw Value(dBuV) + Correction Factor(dB/m)
2. Correction Factor(dB/m) = Antenna Factor (dB/m) + Cable Factor (dB) – Pre-Amplifier Factor (dB)
3. The other emission levels were very low against the limit.
4. Margin value = Emission level – Limit value

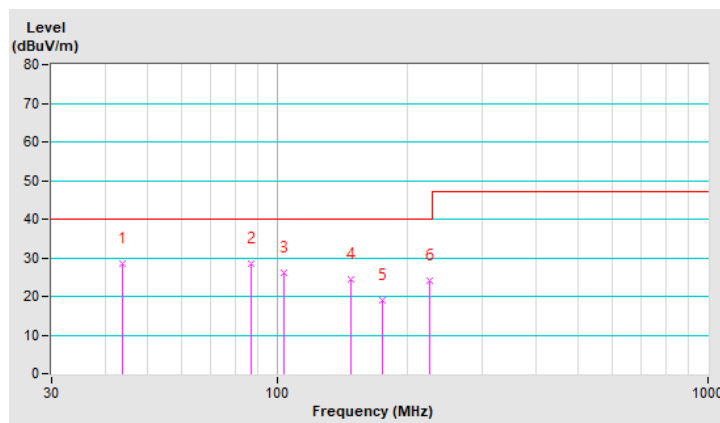

Mode D

Frequency Range	30 MHz ~ 1 GHz	Detector Function & Resolution Bandwidth	Quasi-Peak (QP), 120 kHz
Input Power	24 Vdc	Environmental Conditions	20°C, 70% RH
Tested By	Ed. Lin		

Antenna Polarity & Test Distance : Horizontal at 10 m								
No	Frequency (MHz)	Emission Level (dBuV/m)	Limit (dBuV/m)	Margin (dB)	Antenna Height (m)	Table Angle (Degree)	Raw Value (dBuV)	Correction Factor (dB/m)
1	42.62	27.82 QP	40.00	-12.18	4.00 H	153	36.63	-8.81
2	64.94	26.36 QP	40.00	-13.64	4.00 H	100	36.17	-9.81
3	117.15	26.46 QP	40.00	-13.54	4.00 H	57	37.03	-10.57
4	158.32	25.42 QP	40.00	-14.58	4.00 H	106	33.20	-7.78
5	197.67	19.18 QP	40.00	-20.82	3.74 H	156	29.88	-10.70
6	228.78	20.70 QP	40.00	-19.30	3.34 H	201	30.58	-9.88

Remarks:

1. Emission Level(dBuV/m) = Raw Value(dBuV) + Correction Factor(dB/m)
2. Correction Factor(dB/m) = Antenna Factor (dB/m) + Cable Factor (dB) – Pre-Amplifier Factor (dB)
3. The other emission levels were very low against the limit.
4. Margin value = Emission level – Limit value

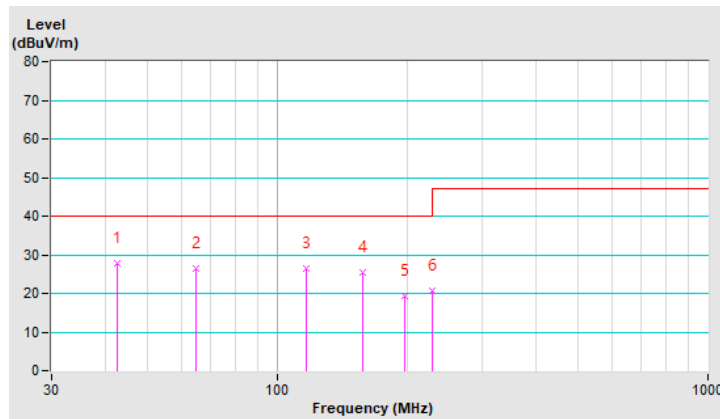

Frequency Range	30 MHz ~ 1 GHz	Detector Function & Resolution Bandwidth	Quasi-Peak (QP), 120 kHz
Input Power	24 Vdc	Environmental Conditions	20°C, 70% RH
Tested By	Ed. Lin		

Antenna Polarity & Test Distance : Vertical at 10 m								
No	Frequency (MHz)	Emission Level (dBuV/m)	Limit (dBuV/m)	Margin (dB)	Antenna Height (m)	Table Angle (Degree)	Raw Value (dBuV)	Correction Factor (dB/m)
1	37.40	29.28 QP	40.00	-10.72	1.00 V	71	38.70	-9.42
2	105.45	29.71 QP	40.00	-10.29	1.00 V	83	41.46	-11.75
3	118.98	27.14 QP	40.00	-12.86	1.00 V	183	37.51	-10.37
4	130.57	26.58 QP	40.00	-13.42	1.00 V	132	35.78	-9.20
5	159.85	20.30 QP	40.00	-19.70	1.00 V	93	28.11	-7.81
6	219.94	22.21 QP	40.00	-17.79	1.00 V	51	32.57	-10.36

Remarks:

1. Emission Level(dBuV/m) = Raw Value(dBuV) + Correction Factor(dB/m)
2. Correction Factor(dB/m) = Antenna Factor (dB/m) + Cable Factor (dB) – Pre-Amplifier Factor (dB)
3. The other emission levels were very low against the limit.
4. Margin value = Emission level – Limit value

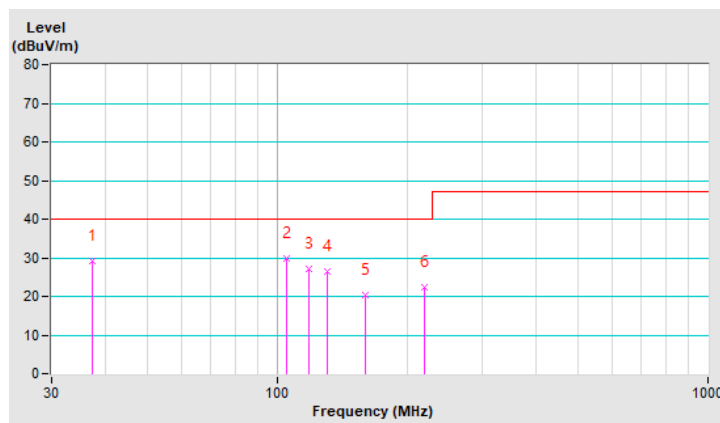

Mode E

Frequency Range	30 MHz ~ 1 GHz	Detector Function & Resolution Bandwidth	Quasi-Peak (QP), 120 kHz
Input Power	24 Vdc	Environmental Conditions	20°C, 70% RH
Tested By	Ed. Lin		

Antenna Polarity & Test Distance : Horizontal at 10 m								
No	Frequency (MHz)	Emission Level (dBuV/m)	Limit (dBuV/m)	Margin (dB)	Antenna Height (m)	Table Angle (Degree)	Raw Value (dBuV)	Correction Factor (dB/m)
1	42.62	25.19 QP	40.00	-14.81	4.00 H	154	34.00	-8.81
2	64.94	29.11 QP	40.00	-10.89	4.00 H	224	38.92	-9.81
3	106.60	29.87 QP	40.00	-10.13	4.00 H	200	41.46	-11.59
4	114.41	29.63 QP	40.00	-10.37	4.00 H	162	40.46	-10.83
5	170.53	22.43 QP	40.00	-17.57	3.20 H	107	30.59	-8.16
6	203.00	23.56 QP	40.00	-16.44	3.47 H	124	34.15	-10.59

Remarks:

1. Emission Level(dBuV/m) = Raw Value(dBuV) + Correction Factor(dB/m)
2. Correction Factor(dB/m) = Antenna Factor (dB/m) + Cable Factor (dB) – Pre-Amplifier Factor (dB)
3. The other emission levels were very low against the limit.
4. Margin value = Emission level – Limit value

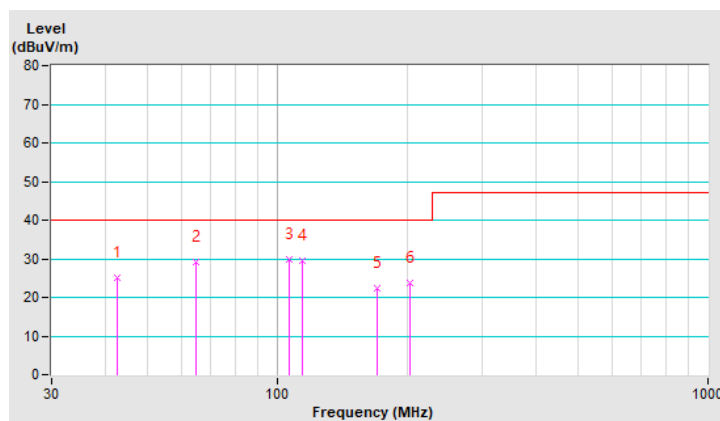

Frequency Range	30 MHz ~ 1 GHz	Detector Function & Resolution Bandwidth	Quasi-Peak (QP), 120 kHz
Input Power	24 Vdc	Environmental Conditions	20°C, 70% RH
Tested By	Ed. Lin		

Antenna Polarity & Test Distance : Vertical at 10 m								
No	Frequency (MHz)	Emission Level (dBuV/m)	Limit (dBuV/m)	Margin (dB)	Antenna Height (m)	Table Angle (Degree)	Raw Value (dBuV)	Correction Factor (dB/m)
1	34.35	32.91 QP	40.00	-7.09	1.00 V	186	42.72	-9.81
2	63.93	33.50 QP	40.00	-6.50	1.00 V	88	43.16	-9.66
3	95.30	31.02 QP	40.00	-8.98	1.00 V	163	44.56	-13.54
4	108.31	26.97 QP	40.00	-13.03	1.00 V	76	38.27	-11.30
5	154.36	23.41 QP	40.00	-16.59	1.00 V	132	31.17	-7.76
6	277.25	24.65 QP	47.00	-22.35	1.00 V	201	31.33	-6.68

Remarks:

1. Emission Level(dBuV/m) = Raw Value(dBuV) + Correction Factor(dB/m)
2. Correction Factor(dB/m) = Antenna Factor (dB/m) + Cable Factor (dB) – Pre-Amplifier Factor (dB)
3. The other emission levels were very low against the limit.
4. Margin value = Emission level – Limit value

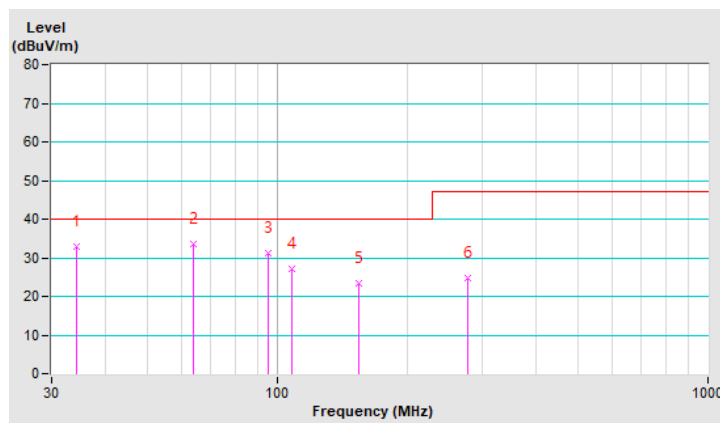

7.3 Electrostatic Discharges (ESD)

Mode A

For EN 55035

Input Power	DC 24V	Environmental conditions	23 °C, 50 % RH 1007 mbar
Tested by	Michael Cheng		

Test Results of Direct Application

Discharge Level (kV)	Polarity (+/-)	Test Point	Contact Discharge	Air Discharge	Performance Criteria
2, 4, 8	+/-	1	---	Note	A

Note: No conductive surfaces, therefore no contact discharge was executed.

Description of test points of direct application: Please refer to following page for representative mark only.

Test Results of Indirect Application

Discharge Level (kV)	Polarity (+/-)	Test Point	Horizontal Coupling Plane	Vertical Coupling Plane	Performance Criteria
2, 4, 6	+/-	Four Side	Note	Note	A

Description of test points of indirect application:

1. Front side
2. Rear side
3. Right side
4. Left side

Please refer to the attached page for description of test points.

Note: The EUT is operated normal during the test.

Description of test point

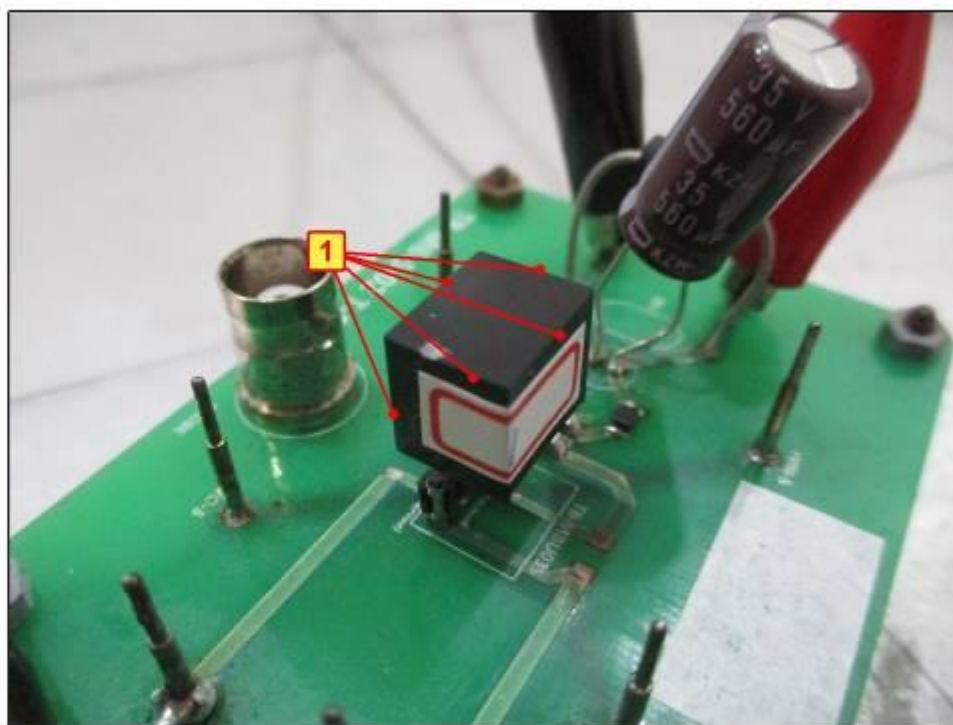

7.4 Radio Frequency Electromagnetic Field (RS)

Mode A

For EN 55035

Input Power	DC 24V	Environmental conditions	16 °C, 72 % RH 1017 mbar
Tested by	Chiming Li		

Frequency (MHz)	Polarity	Azimuth(°)	Applied Field Strength		Observation	Performance Criteria
			(V/m)	Modulation		
80 - 1000	V&H	0, 90, 180, 270	3, 10	80% AM (1kHz)	Note	A
1800, 2600, 3500, 5000	V&H	0, 90, 180, 270	3, 10	80% AM (1kHz)	Note	A

Note: The EUT is operated normal during the test.

7.5 Fast Transients Common Mode (EFT)

For EN 55035

Mode A

Input Power	DC 5V	Environmental conditions	20 °C, 72 % RH 1015 mbar
Tested by	Michael Cheng		

Input DC power port				
Voltage (kV)	Test Point	Polarity (+/-)	Observation	Performance Criteria
0.5, 2	DC(+)	+/-	Note	A
0.5, 2	DC(-)	+/-	Note	A
0.5, 2	DC(+) – DC(-)	+/-	Note	A

Note: The EUT is operated normal during the test.

Mode B

Input Power	DC 12V	Environmental conditions	20 °C, 72 % RH 1015 mbar
Tested by	Michael Cheng		

Input DC power port				
Voltage (kV)	Test Point	Polarity (+/-)	Observation	Performance Criteria
0.5, 2	DC(+)	+/-	Note	A
0.5, 2	DC(-)	+/-	Note	A
0.5, 2	DC(+) – DC(-)	+/-	Note	A

Note: The EUT is operated normal during the test.

Mode C

Input Power	DC 24V	Environmental conditions	20 °C, 72 % RH 1015 mbar
Tested by	Michael Cheng		

Input DC power port				
Voltage (kV)	Test Point	Polarity (+/-)	Observation	Performance Criteria
0.5, 2	DC(+)	+/-	Note	A
0.5, 2	DC(-)	+/-	Note	A
0.5, 2	DC(+) – DC(-)	+/-	Note	A

Note: The EUT is operated normal during the test.

7.6 Surges

For EN 55035

Mode A

Input Power	DC 5V	Environmental conditions	20 °C, 72 % RH 1015 mbar
Tested by	Michael Cheng		

Input DC power port					
Voltage (kV)	Test Point	Azimuth(°)	Polarity (+/-)	Observation	Performance Criteria
0.5, 1	DC(+) – DC(-)	---	+/-	Note	A

Note: The EUT is operated normal during the test.

Mode B

Input Power	DC 12V	Environmental conditions	20 °C, 72 % RH 1015 mbar
Tested by	Michael Cheng		

Input DC power port					
Voltage (kV)	Test Point	Azimuth(°)	Polarity (+/-)	Observation	Performance Criteria
0.5, 1	DC(+) – DC(-)	---	+/-	Note	A

Note: The EUT is operated normal during the test.

Mode C

Input Power	DC 24V	Environmental conditions	20 °C, 72 % RH 1015 mbar
Tested by	Michael Cheng		

Input DC power port					
Voltage (kV)	Test Point	Azimuth(°)	Polarity (+/-)	Observation	Performance Criteria
0.5, 1	DC(+) – DC(-)	---	+/-	Note	A

Note: The EUT is operated normal during the test.

7.7 Radio Frequency Common Mode (CS)

Mode A

For EN 55035

Input Power	DC 24V	Environmental conditions	18 °C, 73 % RH 1017 mbar
Tested by	Chiming Li		

Input AC power port							
Frequency (MHz)	Level (V rms)	Modulation	Tested Line	Injection Method	Return Path	Observation	Performance Criteria
0.15 – 10	3	80% AM (1kHz)	DC Power	CDN-M2	---	Note	A
10 – 30	3~1	80% AM (1kHz)	DC Power	CDN-M2	---	Note	A
30 – 80	1	80% AM (1kHz)	DC Power	CDN-M2	---	Note	A
0.15 – 80	10	80% AM (1kHz)	DC Power	CDN-M2	---	Note	A

Note: The EUT is operated normal during the test.

7.8 Power Frequency Magnetic Field (PFMF)

Mode A

For EN 55035

Input Power	24V	Environmental conditions	19°C, 62% RH 1017mbar
Tested by	Chiming Li		

Application	Frequency (Hz)	Field Strength (A/m)	Observation	Performance Criteria
X - Axis	50	1, 30	Note	A
Y - Axis	50	1, 30	Note	A
Z - Axis	50	1, 30	Note	A

Note: The EUT is operated normal during the test.

8 Pictures of Test Arrangements

8.1 Conducted Emissions from Power Ports

Mode A



Mode B



Mode C



Mode D



Mode E



8.2 Radiated Emissions up to 1 GHz

Mode A

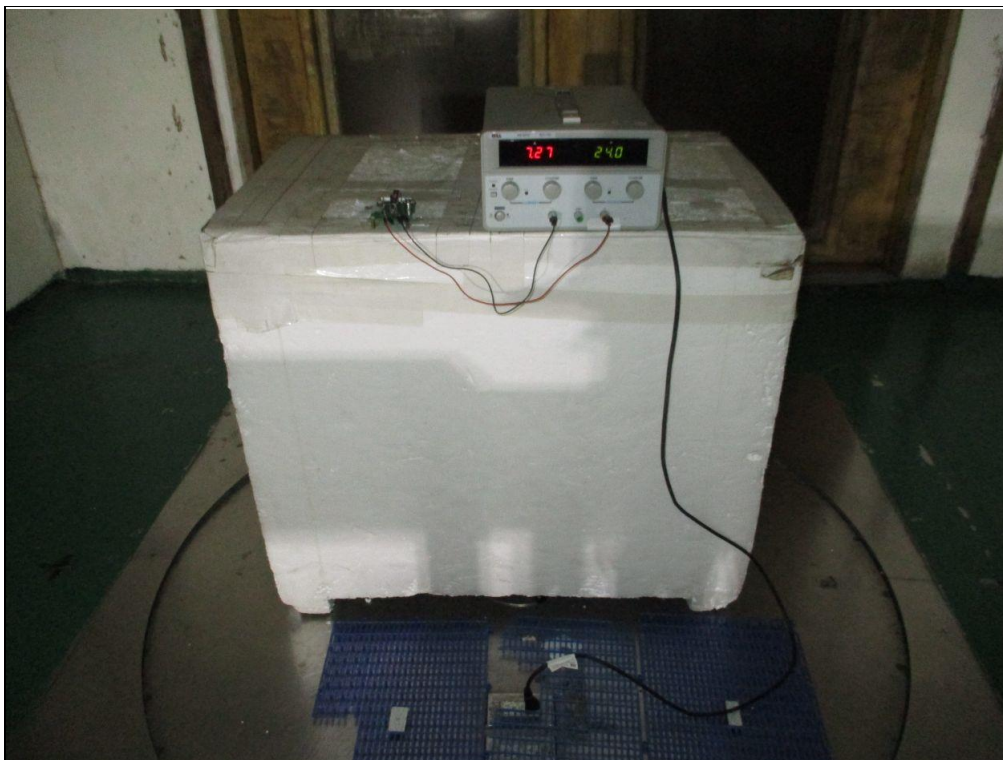
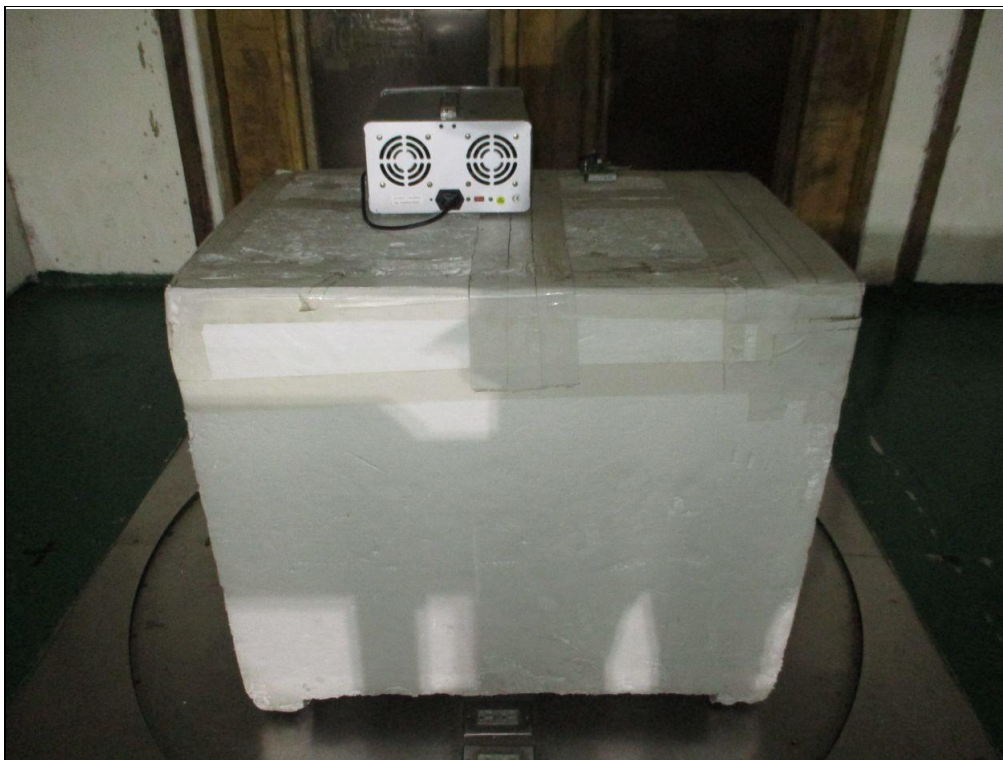

Mode B

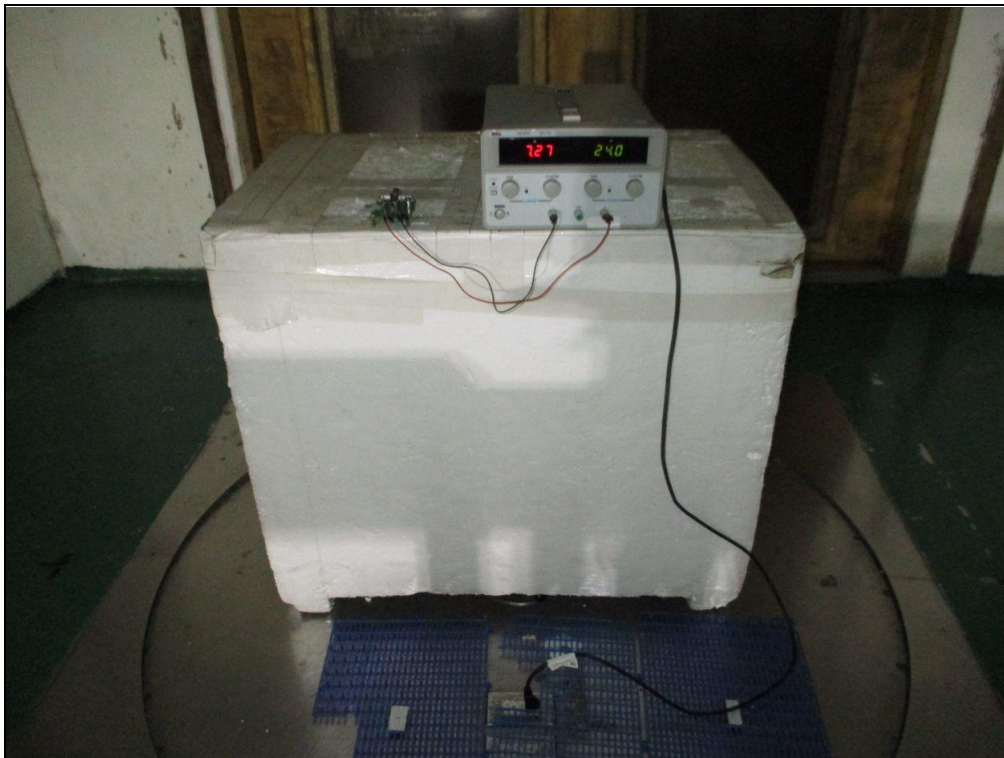
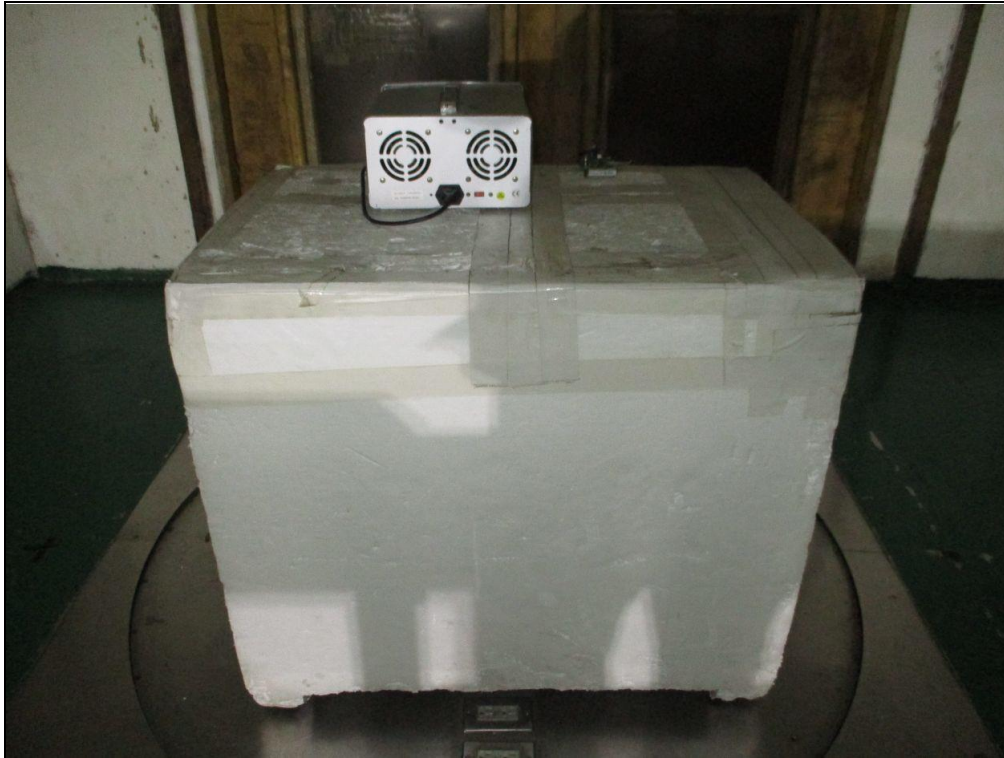

Mode C

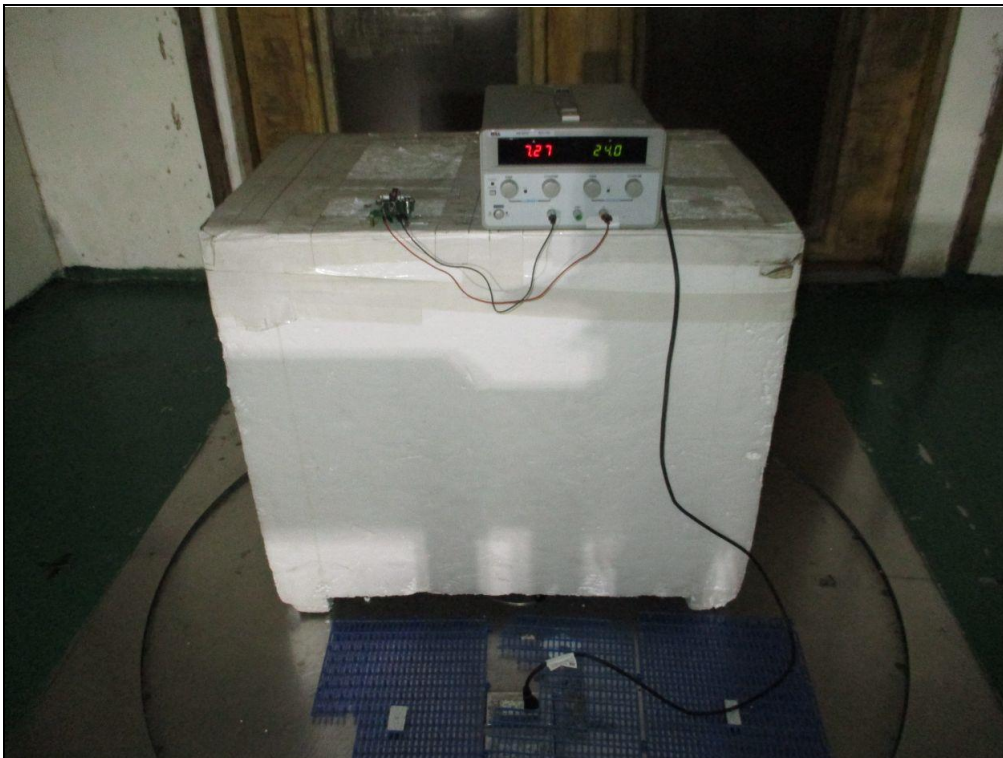
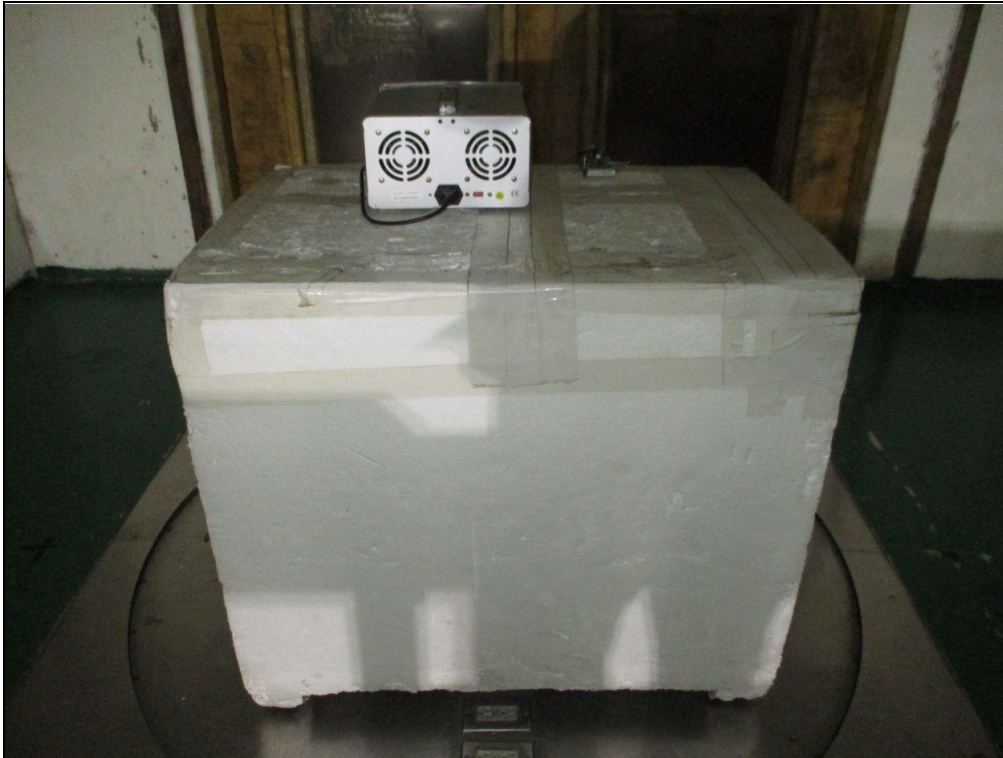

Mode D

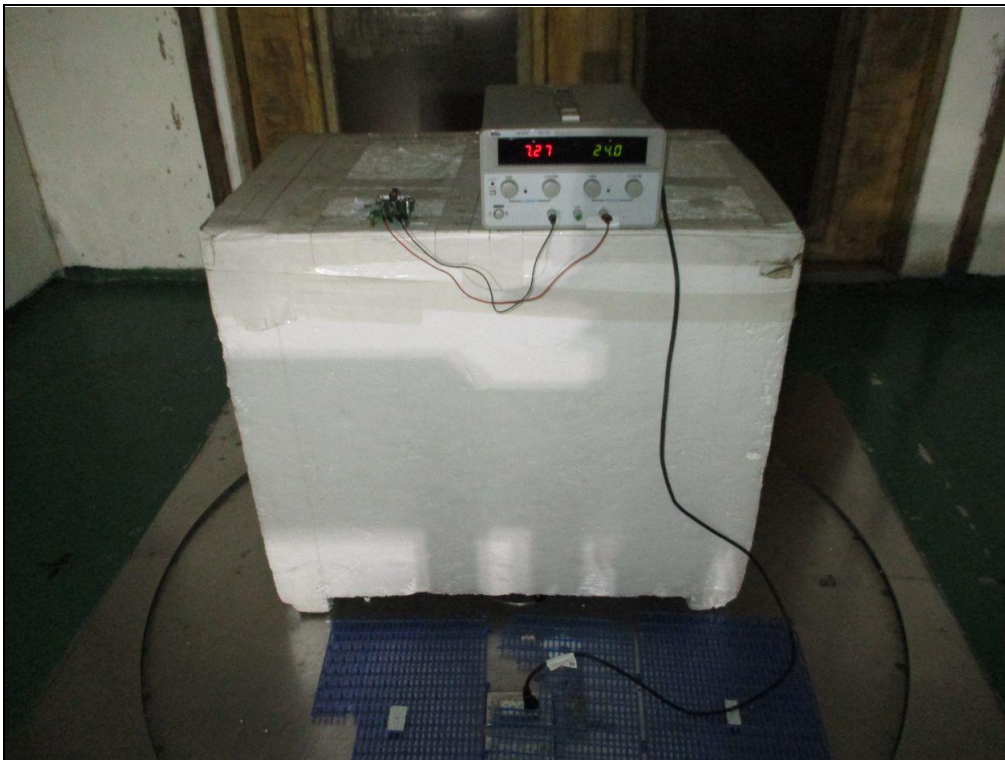
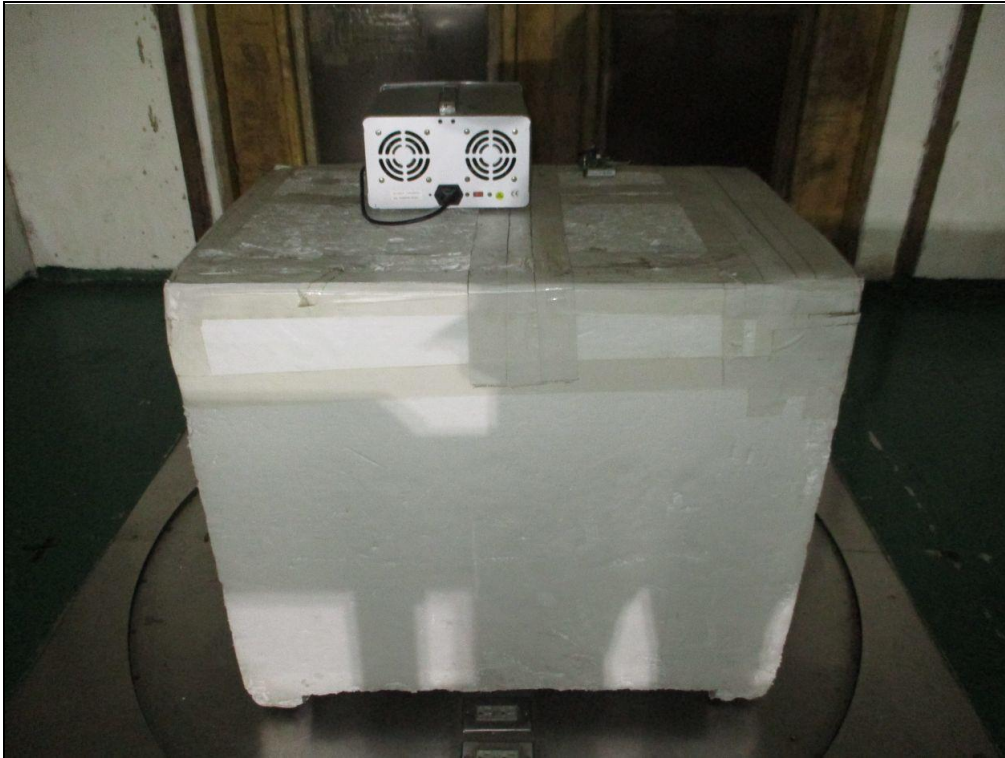

Mode E

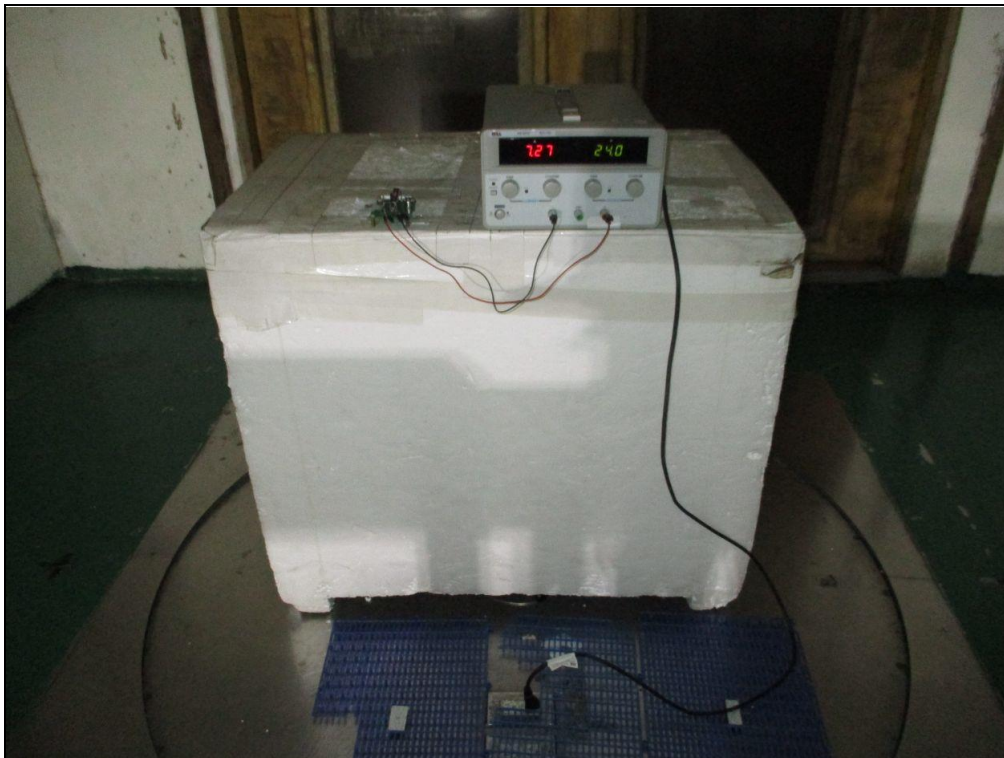
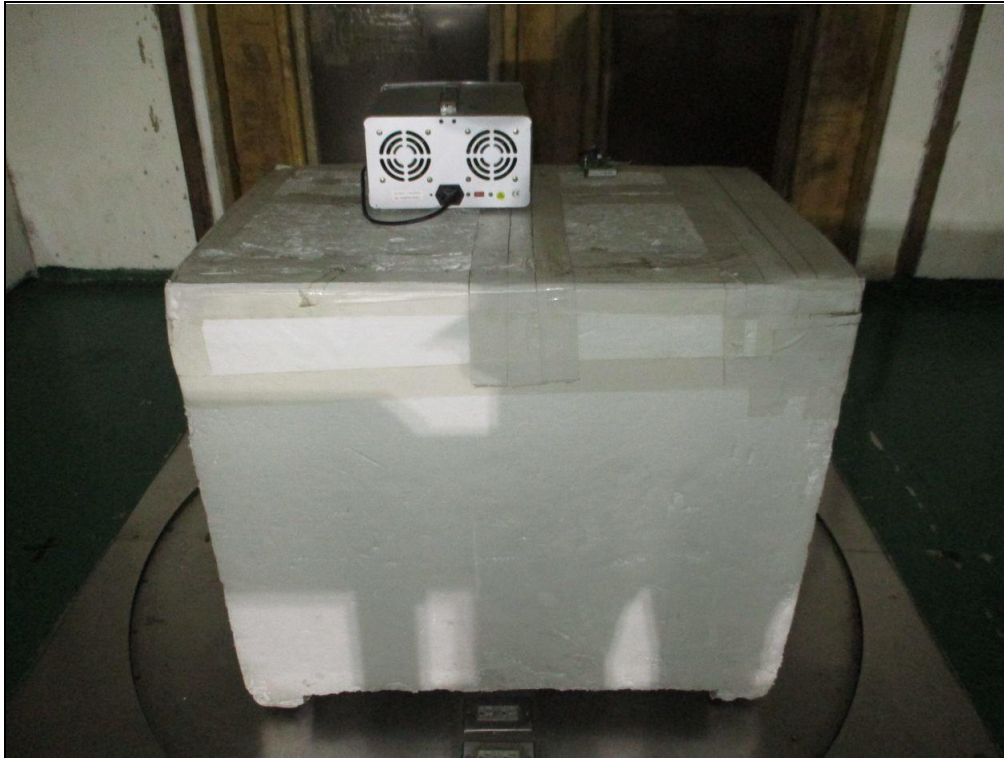

8.3 Electrostatic Discharges (ESD)

Mode A

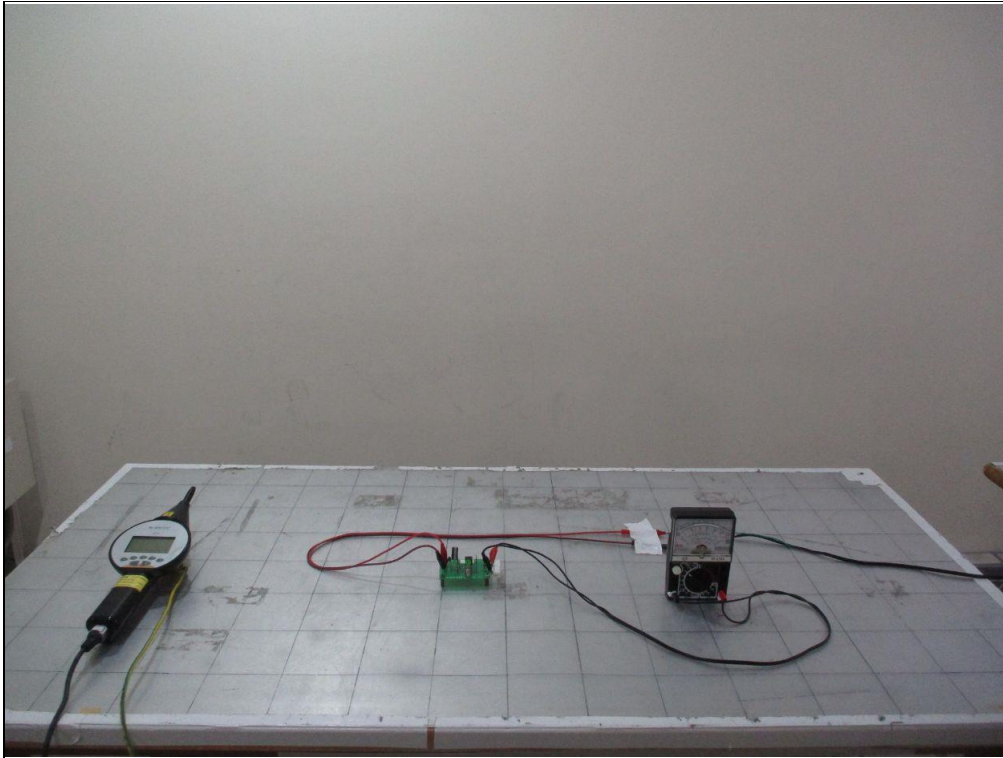

8.4 Radio Frequency Electromagnetic Field (RS)

Mode A

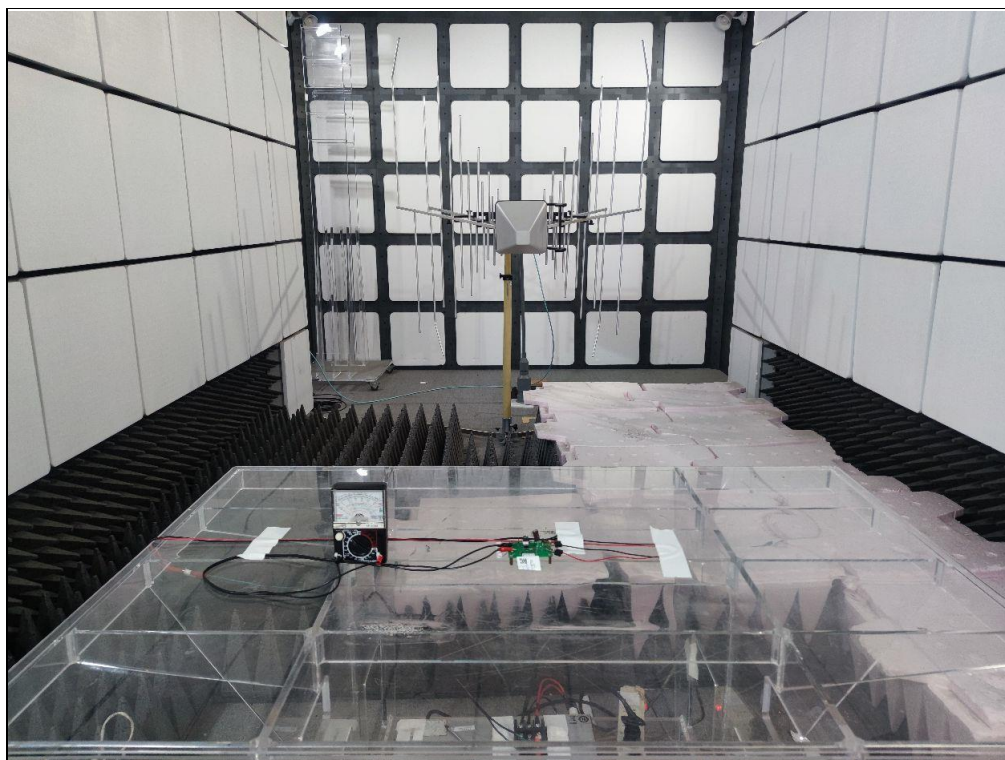

8.5 Fast Transients Common Mode (EFT)

Mode A

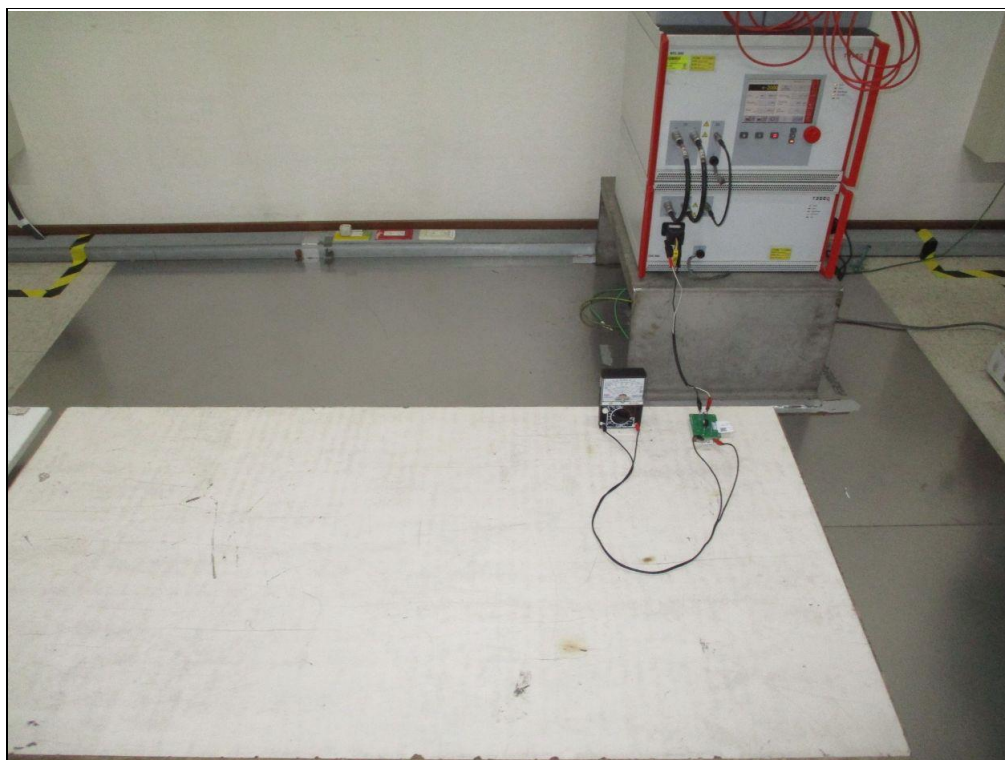

Mode B



Mode C

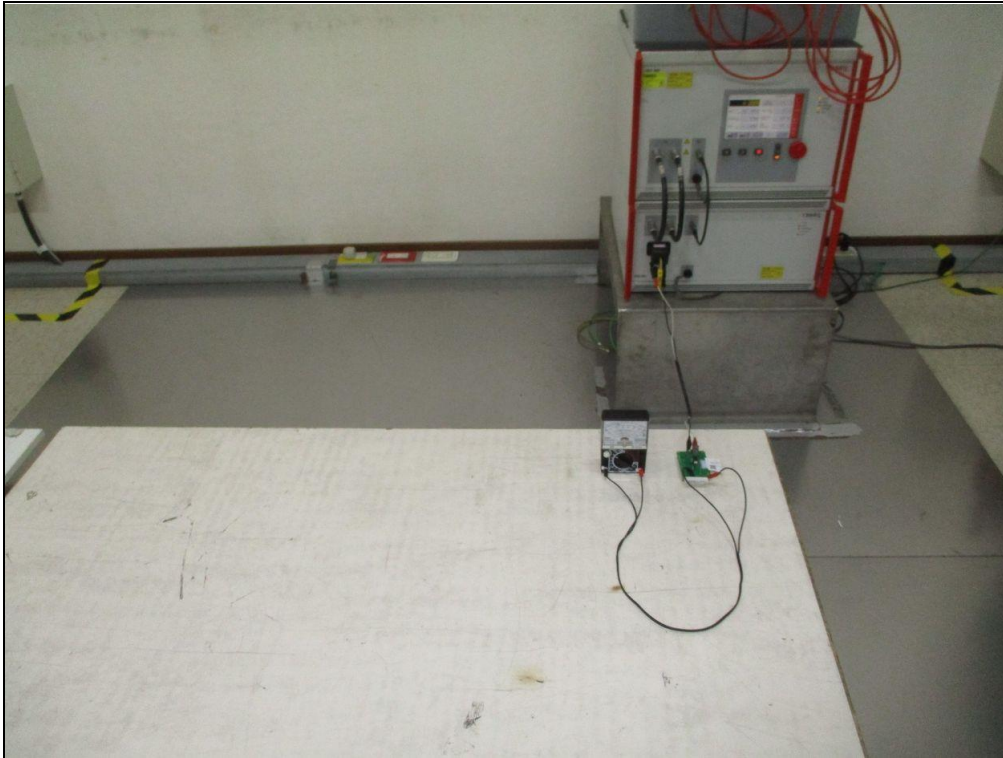

8.6 Surges

Mode A

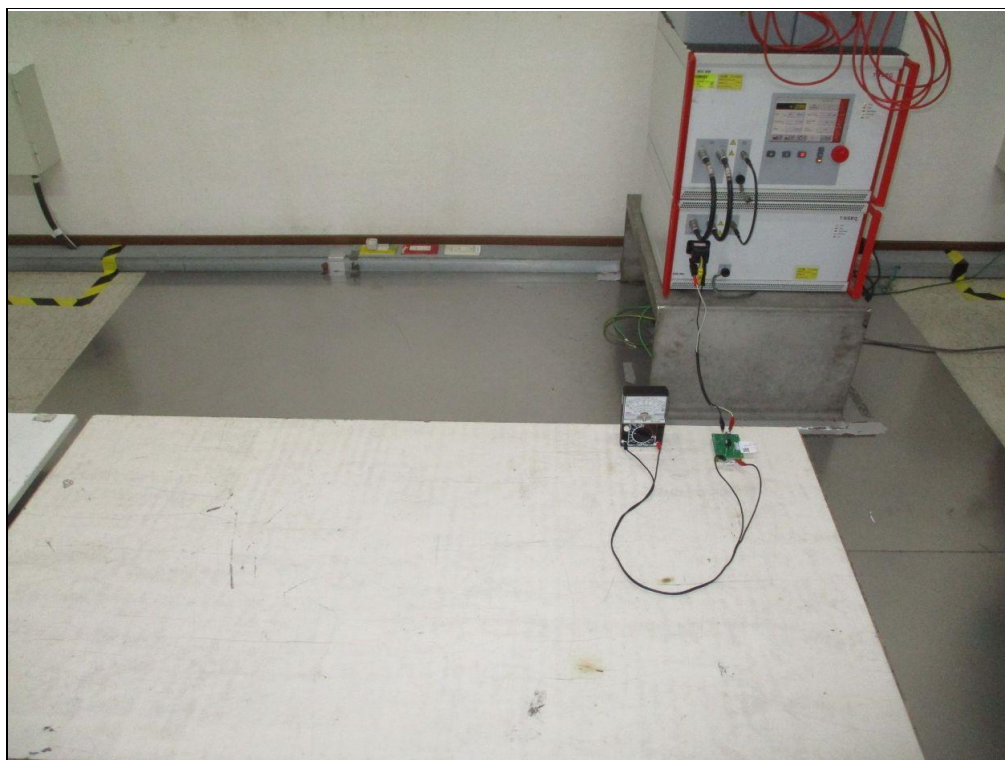

Mode B



Mode C

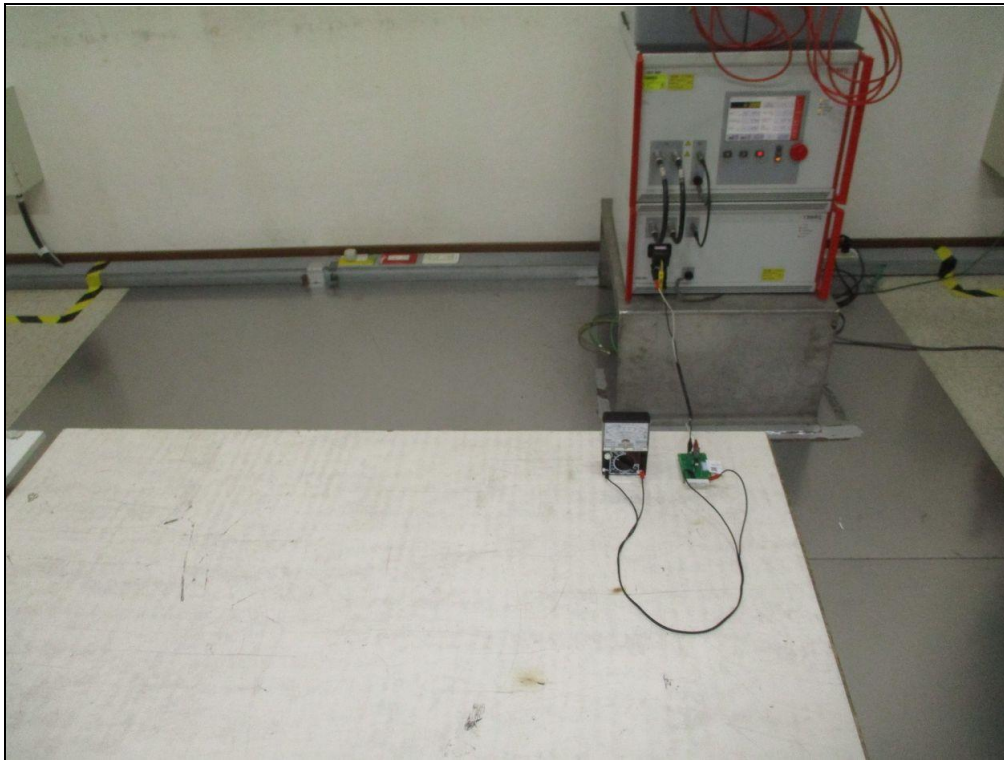

8.7 Radio Frequency Common Mode (CS)

Mode A

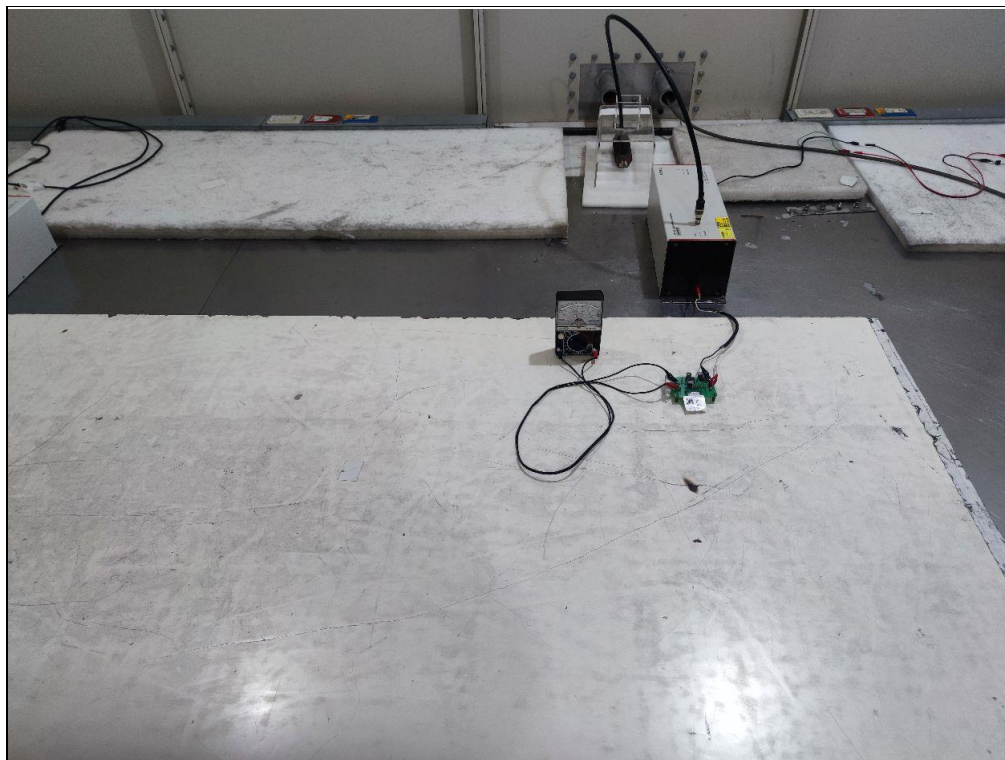

8.8 Power Frequency Magnetic Field (PFMF)

Mode A

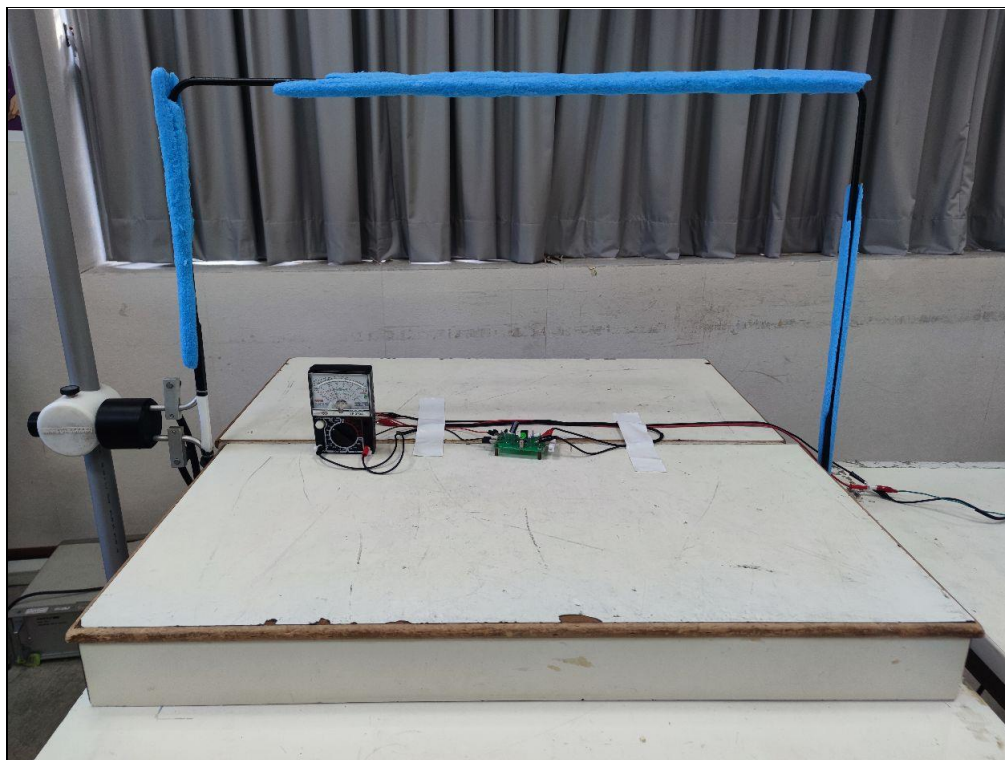

9 Information of the Testing Laboratories

We, Bureau Veritas Consumer Products Services (H.K.) Ltd., Taoyuan Branch, were founded in 1988 to provide our best service in EMC, Radio, Telecom and Safety consultation. Our laboratories are FCC recognized accredited test firms and accredited according to ISO/IEC 17025.

If you have any comments, please feel free to contact us at the following:

Lin Kou EMC/RF Lab

Tel: 886-2-26052180

Fax: 886-2-26051924

Hsin Chu EMC/RF/Telecom Lab

Tel: 886-3-6668565

Fax: 886-3-6668323

Hwa Ya EMC/RF/Safety Lab

Tel: 886-3-3183232

Fax: 886-3-3270892

Email: service.adt@bureauveritas.com

Web Site: <http://ee.bureauveritas.com.tw>

The address and road map of all our labs can be found in our web site also.

--- END ---